

NEW

MP20V

ONE POWERS ALL.

**20V LITHIUM-ION
CORDLESS SYSTEM**



10/2024

CATALOGO
TOLSEN
TOOLS ITALIA

FORNIAMO UN'AMPIA GAMMA DI UTENSILI PROFESSIONALI



CONFEZIONI PER IL RETAIL & DISPLAY DA BANCO

TRADUZIONI DESCRIZIONI ARTICOLI
IN MULTI-LINGUA

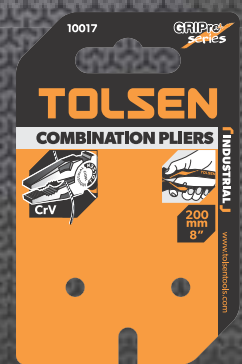

UN TEAM DI DESIGNERS

PROFESSIONISTI

I nostri designers e ingegneri di produzione hanno un elevato livello di competenza tecnica e testano i materiali per progettare e migliorare costantemente i nostri prodotti.

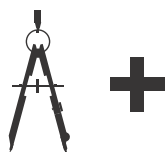

Studiano come rendere il packaging accattivante e d'impatto per i clienti.

I NOSTRI PRODOTTI VENGONO TESTATI

SECONDO GLI STANDARD EUROPEI

PIÙ SICURI



CONTROLLO QUALITA' DURANTE OGNI STEP DELLA PRODUZIONE

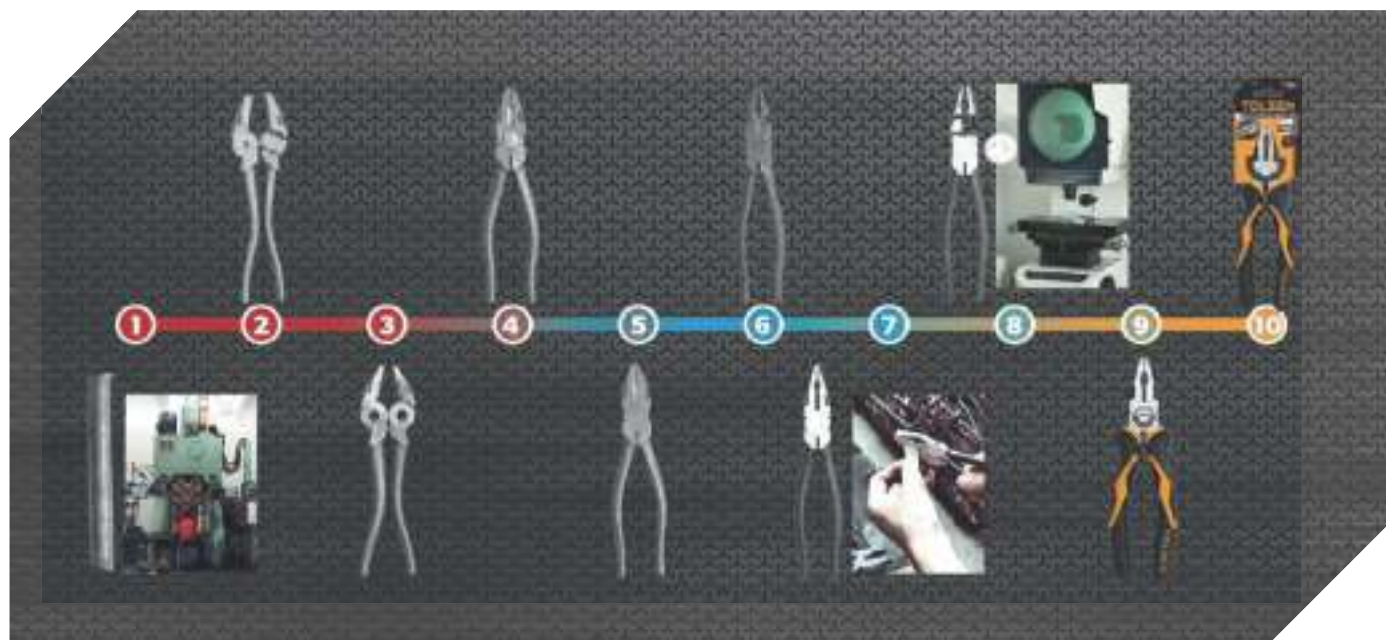

TOLSEN

TOOLS AND MORE

UNA GAMMA COMPLETA DI STRUMENTI PROFESSIONALI

progettati per migliorare il lavoro quotidiano grazie
all'elevato standard di qualità e al rapporto
qualità/prezzo competitivo

18
CATEGORIE

+1400
REFERENZE

NEW

nuovi prodotti aggiunti con
frequenza mensile



**UTENSILI
MANUALI**



**UTENSILI DI
MANOVRA**



**UTENSILI DI
FISSAGGIO**



**MARTELLI
E SCALPELLI**



**UTENSILI DA
TAGLIO**



**UTENSILI DA
GIARDINO**



**UTENSILI PER
FINITURA**



TERMOIDRAULICA



**STRUMENTI DI
MISURAZIONE**



**UTENSILI PER
ELETTRICISTI**



**UTENSILI ISOLATI VDE
SERIE PREMIUM**



**UTENSILI PER
EDILIZIA**



**DOTAZIONI
DI
SICUREZZA**



**ACCESSORI PER
ELETTROUTENSILI**



**CASSETTE E
BORSE PORTATTREZZI**



**UTENSILI PER
SALDATURA**



ELETTROUTENSILI



ELETTROUTENSILI A BATTERIA UNICA

TOLSENTM

TOOLS AND MORE



**massima
forza con
il minimo
sforzo**



Lama in acciaio CrV

Comodo foro da gancio

Impronta magnetica lavorata ad alta precisione

TOLSEN

UTENSILI MANUALI



PINZE COMBinate EASY



Acciaio speciale per utensili forgiato a goccia
Nichelato
Manico in plastica bicomponente

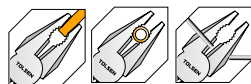

Codice	Misura	Pz/Conf	Master
10000T	160mm	6	48
10001T	180mm	6	48
10002T	200mm	6	48

PINZE BECCHI CURVI 160mm EASY



160mm
Acciaio speciale per utensili forgiato a goccia
Nichelato
Manico in plastica bicomponente



Codice	Misura	Pz/Conf	Master
10008T	160mm	6	48

PINZE TRONCHESI EASY



Acciaio speciale per utensili forgiato a goccia
Nichelato
Manico in plastica bicomponente



Codice	Misura	Pz/Conf	Master
10003T	160mm	6	48
10004T	180mm	6	48

PINZE COMBinate



Cr-V, finitura nera
Manico in plastica bicomponente

GRIPPro series

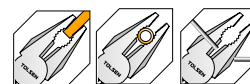

Codice	Misura	Pz/Conf	Master
10015T	160mm	6	36
10016T	180mm	6	36
10017T	200mm	6	36

INDUSTRIAL

PINZE BECCHI LUNGI EASY



Acciaio speciale per utensili forgiato a goccia
Nichelato
Manico in plastica bicomponente



Codice	Misura	Pz/Conf	Master
10006T	160mm	6	48
10007T	200mm	6	48

PINZE TRONCHESI



Cr-V, finitura nera
Manico in plastica bicomponente

GRIPPro series



Codice	Misura	Pz/Conf	Master
10018T	160mm	6	36
10019T	180mm	6	36

INDUSTRIAL

PINZE BECCHI LUNGI



Cr-V, finitura nera
Manico in plastica bicomponente



GRIPPro series



INDUSTRIAL

Codice	Misura	Pz/Conf	Master
10021T	160mm	6	36
10022T	200mm	6	36

MINI PINZE BECCHI LUNGI PER ELETTRONICA 115MM



115 mm
Acciaio speciale per utensili forgiato a goccia placcato nichel
Manico rivestito



Codice	Misura	Pz/Conf	Master
10031T	115mm	12	72

PINZE BECCHI CURVI 160mm



160mm, 6"
Cr-V, finitura nera
Manico in plastica bicomponente



GRIPPro series



INDUSTRIAL

Codice	Misura	Pz/Conf	Master
10023T	160mm	6	36

MINI PINZE TRONCHESI PER ELETTRONICA 115MM



115 mm
Acciaio speciale per utensili forgiato a goccia placcato nichel
Manico rivestito



Codice	Misura	Pz/Conf	Master
10033T	115mm	12	72

MINI PINZE COMBinate PER ELETTRONICA 115MM



115 mm
Acciaio speciale per utensili forgiato a goccia placcato nichel
Manico rivestito



Codice	Misura	Pz/Conf	Master
10030T	115mm	12	72

SET 3 PZ MINI PINZE PER ELETTRONICA 115MM



115 mm
Acciaio speciale per utensili forgiato a goccia placcato nichel
Manico rivestito



Codice	Misura	Pz/Conf	Master
10038T	115mm	6	48

TENAGLIE



Acciaio per utensili di alta qualità forgiato a goccia Finitura nera Manico rivestito



INDUSTRIAL

Codice	Misura	Pz/Conf	Master
10039T	200mm	6	36
10040T	230mm	6	36
10041T	250mm	6	36
10042T	280mm	5	30

TAGLIABULLONI

lama Cr-V da 12" finitura nera



INDUSTRIAL

Codice	Misura	Pz/Conf	Master
10059T	300mm	5	20
10060T	350mm	4	16
10061T	450mm	3	10
10062T	600mm	3	6
10063T	750mm	2	4
10064T	900mm	1	3

TENAGLIA DA FALEGNAME 200mm



200 mm, 8" Acciaio per utensili di alta qualità forgiato a goccia Finitura nera Manico rivestito

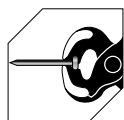

INDUSTRIAL

Codice	Misura	Pz/Conf	Master
10045T	200mm	6	36

TAGLIABULLONI MINI 200mm



Lama da 65Mn Taglienti temprati a induzione con comode impugnature in pvc Un lucchetto all'estremità del manico Manico in plastica 200 mm



Codice	Misura	Pz/Conf	Master
10066T	200mm	6	60

PINZE PER RECINZIONI 250mm



250mm acciaio al carbonio forgiato a goccia con trattamento termico. Impugnatura rivestita



Codice	Misura	Pz/Conf	Master
10301T	250mm	6	24

PINZE PER ANELLI 4 IN 1 TESTE INTERCAMBIABILI



150mm Acciaio per utensili di alta qualità 2 pezzi 180° 1 pezzo da 90° 1 pezzo da 45°

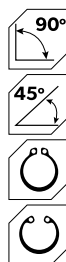

Codice	Misura	Pz/Conf	Master
10100T	160mm	6	48

PINZE A SCATTO CON SGANCIO RAPIDO

INDUSTRIAL



Cr-V 10"
HRC52-HRC56
Apertura massima: 50 mm
Nichelato

Codice	Misura	Pz/Conf	Master
10049T	250mm	6	36

PINZE AUTOBLOCCANTI GANASCE PIATTE



Larghezza ganasce: 100 mm
Profondità della gola: 50 mm
Apertura massima: 15 mm
Acciaio speciale per utensili forgiato a goccia
Placcato nickel

Codice	Misura	Pz/Conf	Master
10055T	250mm	4	24

PINZE A CATENA AUTOBLOCCANTE

INDUSTRIAL



Acciaio speciale per utensili
Placcato nickel
Lunghezza della catena: 460 mm
Peso netto: 730 g

Codice	Misura	Pz/Conf	Master
10050T	250mm	5	20

PINZE AUTOBLOCCANTI GANASCE A C

INDUSTRIAL



Cr-V
HRC52-HRC56
Apertura massima: 90 mm
Acciaio speciale per utensili forgiato a goccia
Placcato nickel

NEW

Codice	Misura	Pz/Conf	Master
10056T	280mm	4	24

PINZE A SCATTO CON SGANCIO RAPIDO



Apertura massima: 50 mm
Acciaio speciale per utensili forgiato a goccia
Nichelato
HRC38-HRC45

NEW

Codice	Misura	Pz/Conf	Master
10051T	250mm	6	36

PINZE AUTOBLOCCANTI GANASCE A C



Acciaio speciale per utensili
Placcato nickel
Lunghezza chiusa: 440 mm
Lunghezza di serraggio: 230 mm
Apertura massima delle ganasce: 180 mm
Dimensioni dei cuscinetti girevoli: 28x28 mm

NEW

Codice	Misura	Pz/Conf	Master
10058T	440mm	4	16

PINZE AUTOBLOCCANTI GANASCE DRITTE



Apertura massima: 65 mm
Acciaio speciale per utensili forgiato a goccia
Nichelato
HRC38-HRC45

Codice	Misura	Pz/Conf	Master
10052T	230mm	6	36



FUSTELLATRICE DA 220mm



220 mm
Dimensioni dei fori: 2 mm, 2,5 mm, 3 mm, 3,5 mm, 4 mm, 4,5 mm
40Cr, cromato temprato



Codice	Misura	Pz/Conf	Master
10101T	220mm	6	48

MORSETTO A C

75mm
Barra verniciata a polvere gialla
Barra filettata zincata



Codice	Misura	Pz/Conf	Master
10112T	75mm	12	48
10113T	100mm	10	30
10114T	150mm	8	16
10115T	200mm	6	12

MORSETTO A VITE

Barra nichelata da 50 * 250 mm, barra filettata zincata
Spessore e larghezza del righello di ferro: 4,5x14,5 mm
Manico in legno



Codice	Misura	Pz/Conf	Master
10125T	50x250mm	5	30
10151T	120x300mm	5	12
10153T	120x500mm	5	10

MORSETTO A PINZA

Mascelle in PE con corpo in miscela PP + fibra di vetro da 4"



Codice	Misura	Pz/Conf	Master
10198T	100mm	25	100
10199T	150mm	25	100
10200T	230mm	25	100

MORSETTO A BARRA CON SGANCIO RAPIDO

150mm
Corpo in plastica rigida
Barra con finitura nera
Cuscinetti morbidi antitraccia



Codice	Misura	Pz/Conf	Master
10201T	150mm	8	32
10204T	300mm	6	24

SET 4PZ MORSETTI A CRICCHETTO



2 pezzi 100mm + 2 pezzi 150mm
Corpo in plastica dura
Barra con finitura nera Cuscinetti morbidi antitraccia



Codice	Misura	Pz/Conf	Master
10209T	2pz 100mm + 2pz 150mm	6	10

STRINGENTE ANGOLARE 75MM

Peso: 220 g
75 mm
Materiale: lega di alluminio
Verniciato a polvere
Barra filettata zincata



INDUSTRIAL

Codice	Misura	Pz/Conf	Master
10218T	75mm	6	36

PINZE MULTIFUNZIONI 14 IN 1 DISPLAY 12PZ



Acciaio 2Cr13 102x46x23mm
Con superficie lucida



14 IN 1
MULTITOOLES

Codice	Misura	Pz/Conf	Master
30046T	102x46x23mm	12	24

SET 3PZ UTENSILI MISTI EASY

1 pinza combinata da 180 mm
1 pinza per pompa dell'acqua da 250 mm
1 Pinze regolabili da 250mm Acciaio speciale forgiato a goccia, superficie nichelata



Codice	Misura	Pz/Conf	Master
10403T	180 - 200 - 250mm	8	16

SET 3pz PINZE MISTE

1pz Pinze combinate da 200mm
1pz Pinze a becchi lunghi da 160mm
1pz Pinze tronchesi da 160mm
Cr-V, finitura nera
Manico in plastica bicomponente



INDUSTRIAL

Codice	Misura	Pz/Conf	Master
10410T	200 - 160 - 160mm	5	20

GRIPPro series

UTENSILI CON NUOVE IMPUGNATURE DAL DESIGN ERGONOMICO

Impugnatura ergonomica per un trasferimento ottimale della potenza.

La combinazione di duro e morbido riduce lo slittamento e affaticamento della mano

GRIPPro
series



TOLSEN

UTENSILI PER IDRAULICA



PINZE REGOLABILI 250mm EASY



250mm
Acciaio speciale per utensili forgiato a goccia
Nichelato
Manico in plastica bicomponente

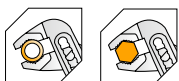

Codice	Misura	Pz/Conf	Master
10014T	250mm	6	36

PINZE REGOLABILI 250mm



250mm, 10"
Cr-V, finitura nera
Manico in plastica bicomponente



GRIPPro series

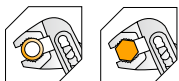

Codice	Misura	Pz/Conf	Master
10029T	250mm	6	36

CHIAVI GIRATUBI

Mascella mobile forgiata a goccia con acciaio Cr-MO di alta qualità
Impugnatura a immersione



Codice	Misura	Pz/Conf	Master
10067T	200mm	6	36
10068T	250mm	6	24
10069T	300mm	6	12
10070T	350mm	4	8
10071T	450mm	3	6
10072T	600mm	2	4
10073T	900mm	1	2

GIRATUBI SVEDESI 90°



Ganascia mobile forgiata a goccia con acciaio Cr-V di alta qualità
Diametro massimo di serraggio: 40 mm 1"



Codice	Misura	Pz/Conf	Master
10251T	40mm	3	24
10252T	55mm	3	12
10253T	67mm	2	8
10254T	103mm	2	4

GIRATUBI SVEDESI 45°



Ganascia mobile forgiata a goccia con acciaio Cr-V di alta qualità
Diametro massimo di serraggio: 40 mm 1"



Codice	Misura	Pz/Conf	Master
10256T	40mm	3	24
10257T	55mm	3	12
10258T	67mm	2	8
10259T	103mm	2	4

PINZE REGOLABILI 300MM



Dimensioni: 300 mm / 12"
La struttura della scanalatura offre una maggiore durata
Ampia regolazione dell'apertura per adattarsi a tutte le forme
Acciaio speciale per utensili forgiato
Impugnatura antiscivolo



Codice	Misura	Pz/Conf	Master
10322T	300mm	6	24

PINZE REGOLABILI CON SGANCIO RAPIDO

INDUSTRIAL



CrV, finitura nera
Dimensione massima apertura
ganascia: 34 mm
Impugnatura rivestita

Codice	Misura	Pz/Conf	Master
10329T	250mm	6	36
10330T	300mm	6	36

CHIAVE REGOLABILE A RULLINO MINI

INDUSTRIAL



Apertura max: 30mm
Realizzata in acciaio Cr-v
Finitura cromata
Manico in plastica bicomponente



Codice	Misura	Pz/Conf	Master
15280T	165mm	6	36

CHIAVI A RULLINO PROFESSIONALI

INDUSTRIAL



GRIPPre series

Dimensione morsetto regolabile:
0-19mm
Acciaio per utensili di alta qualità
forgiato a goccia
Finitura nera e lucidata
Manico in plastica bicomponente

PINZE REGOLABILI 400MM



Dimensioni: 400 mm / 16"
La struttura della scanalatura offre una
maggiore durata
Ampia regolazione dell'apertura per
adattarsi a tutte le forme
Acciaio speciale per utensili forgiato
Impugnatura anticivolo



Codice	Misura	Pz/Conf	Master
10326T	400mm	4	16

CHIAVE GIRATUBI A RULLINO REGOLABILE



CHIAVI REGOLABILI A RULLINO



150 mm
Dimensioni del morsetto regolabile:
0-19,2 mm
Acciaio speciale per utensili forgiato a
goccia
Finitura cromata

Codice	Misura	Pz/Conf	Master
15001T	150mm	6	96
15002T	200mm	6	48
15003T	250mm	6	36
15004T	300mm	6	24
15005T	375mm	4	16
15006T	450mm	2	12

Codice	Misura	Pz/Conf	Master
95259	7" / 178mm	6	48
95259	9" / 225mm	6	48
95259	10.5" / 266mm	6	48

SET 2PZ CHIAVI UNIVERSALI



9-32mm
Acciaio speciale per utensili di alta
qualità
Superficie cromata
Manico in plastica bicomponente

Codice	Misura	Pz/Conf	Master
15282T	9-32mm	6	24

CESOIA PER TUBI PVC/PPR/PU/PE/PEX



225mm
 Diametro di taglio: 3-42mm
 corpo in alluminio
 Lama 3Cr13
 Funzione di apertura automatica
 impugnatura IN abs
 Adatto per
 PVC/PPR/PU//PE/PEX

INDUSTRIAL



Codice	Misura	Pz/Conf	Master
33001T	225mm	6	24

CESOIA PER TUBI IN RAME 6-64mm



Diametro di taglio: 6-64 mm
 Materiale: corpo in lega di alluminio

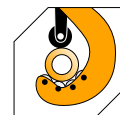

Codice	Misura	Pz/Conf	Master
33006T	6-64mm	6	24

CESOIA MINI PER TUBI IN RAME 3-22mm



Diametro di taglio: 3-22 mm
 Materiale: corpo in lega di alluminio

Codice	Misura	Pz/Conf	Master
33003T	3-22mm	10	80

CESOIA PER TUBI IN PVC EX 33000T



225 mm
 Diametro di taglio:
 3-42mm
 materiale corpo in alluminio
 Lama 65Mn
 Funzione di apertura
 automatica
 per
 PVC/PPR/PU//PE/PEX



Codice	Misura	Pz/Conf	Master
33100T	200mm	6	48

CESOIE



Diametro di taglio: 3-28 mm
 Materiale: corpo in lega di alluminio

Codice	Misura	Pz/Conf	Master
33004T	3-28mm	5	50
33005T	3-32mm	5	50

SPIRALI SGOMBRATUBO A MOLLA



Acciaio completamente flessibile
 Con manico in plastica
 Con gancio ad "S" zincato

Codice	Misura	Pz/Conf	Master
50101T	diam. 9mm x 5mt	10	10
50102T	diam. 9mm x 10mt	5	5



TOLSEN

UTENSILI DI MANOVRA



SNODI CARDANICI



Finitura satinata

1/2"

3/8"

1/4"

INDUSTRIAL

Codice	Misura	Pz/Conf	Master
15132T	1/4" x 40mm	6	144
15133T	3/8" x 56mm	6	72
15134T	1/2" x 75mm	6	36

QUADRI MASCHI CON SPINA



Dimensioni
Cr-V: 1/4" x 115mm
Finitura satinata

1/2"

3/8"

1/4"

Codice	Misura	Pz/Conf	Master
15129T	1/4" x 115mm	6	144
15130T	3/8" x 160mm	6	72
15131T	1/2" x 250mm	6	36

PROLUNGHE



Finitura satinata

1/2"

3/8"

1/4"

Codice	Misura	Pz/Conf	Master
15121T	1/4" x 50mm	6	144
15122T	1/4" x 100mm	6	72
15123T	3/8" x 75mm	6	72
15124T	3/8" x 150mm	6	72
15127T	1/2" x 125mm	6	72
15128T	1/2" x 250mm	6	36

CHIAVI A DOPPIA PIPA

Acciaio speciale per utensili forgiato a goccia, trattato termicamente con finitura antiantimacchia, cromato.

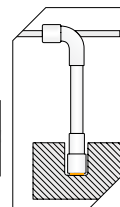
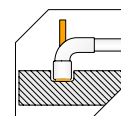
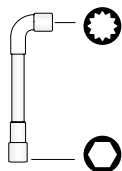

Codice	Misura	Pz/Conf	Master
15087T	8mm	10	120
15089T	10mm	10	100
15092T	13mm	10	60
15096T	17mm	5	40
15098T	19mm	5	30

SET 9PZ CHIAVI A DOPPIA PIPA

Acciaio speciale per utensili forgiato a goccia, trattato termicamente con finitura antiantimacchia, cromato.

NEW

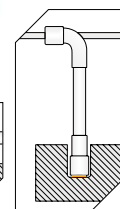
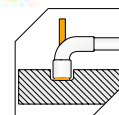
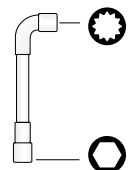

Codice	Misura	Pz/Conf	Master
15086T	7-8-10-11-12-13-14-17-19mm	5	10

CHIAVE A CROCE PER RUOTE AUTO



Dimensione: 14 * 17 * 19 * 21 * 23 mm
Materiale: Cr-V verniciato a polvere
Il design a croce offre leva e torsione extra



Codice	Misura	Pz/Conf	Master
15079T	17-19-21-23mm	4	12

CASSETTA 22PZ CRICCHETTO REVERSIBILE CON BUSSOLE DA 1/2"

22pz attacco da 1/2"
 15 prese metriche Cr-V: 10,11,12,13,14,15,16,17,18,19,22,24,27,30,32mm;
 1pz Manico a cricchetto bicomponente, 72T
 2pz Prese per candele Cr-V: 16,21mm;
 2 barre di estensione Cr-V: 125, 250mm;
 1 pz giunto universale Cr-V;
 1pz Adattatore a 3 vie Cr-V;



Codice	Misura	Pz/Conf	Master
15139T	1/2"	1	4

CASSETTA 46PZ CRICCHETTO REVERSIBILE CON BUSSOLE DA 1/4"

46pz attacco da 1/4"
 21 punte a bussola, materiale S2 delle punte:
 Torx: T10, T15, T20, T25, T30, T40;
 Phillips: PH1, PH2, PH3;
 Fisse: 4, 5,5, 6,5 mm;
 Pozidriv: PZ1, PZ2, PZ3;
 Esagonale: 2, 2,5, 3, 4, 5, 6mm;
 1pz Impugnatura a cricchetto bicomponente, 72T 13pz prese metriche Cr-V: 4, 4,5, 5, 5,5, 6, 7, 8, 9, 10, 11, 12, 13, 14mm;
 1 pz barra scorrevole Cr-V; 1 manico per cacciavite Cr-V; 1pz Giunto universale Cr-V; 2 barre di estensione Cr-V: 50.100mm; Adattatore 1pz Cr-V: 25mm; Barra flessibile 1pz Cr-V: 150mm; 4 chiavi esagonali Cr-V: 1,27, 1,5, 2,0, 2,5 mm



Codice	Misura	Pz/Conf	Master
15138T	1/4"	1	10

CASSETTA 45PZ CRICCHETTI CON BUSSOLE E PROLUNGHE

45pz attacco da 1/4 "e 1/2"
 18 pezzi 1/2" prese metriche Cr-V:
 10,11,12,13,14,15, 16,17,18,19,20,21,22,23, 24,27,30,32mm
 2pz maniglie a cricchetto bicomponente, 72T:
 1/2", 1/4"; 1pz giunto universale Cr-V 1/2"; 2 pz Cr-V 1/2" barra di estensione: 125.250 mm; 1 pz Cr-V 1/2" adattatore a 3 vie; 2 prese per candele Cr-V: 16,21mm;
 12 bussole metriche Cr-V 1/4": 4,5,5,5,6,7,8,9,10,11,12,13,14 mm; 1 giunto cardanico Cr-V 1/4"; 2 barre di estensione Cr-V 1/4": 50.100 mm; 1 barra scorrevole Cr-V 1/4" 115 mm;
 1 barra flessibile da 150 mm; 1 manico per presa da 150 mm;



Codice	Misura	Pz/Conf	Master
15142T	1/4" - 1/2"	1	4

CASSETTA 94PZ CRICCHETTI CON BUSSOLE E PROLUNGHE

94pz attacco da 1/4 "e 1/2"
 PZ 1 pz impugnatura a cricchetto bicomponente, 72T: 1/2"; 18 pz 1/2 "Cr-V prese metriche standard: 10,11,12,13,14,15,16,17,18,19,20,21,22,23,24,27,30,32mm;
 4 prese metriche 1/2" Cr-V profonde: 14-15-17-19 mm; 1 giunto cardanico Cr-V 1/2"; 2 pz Cr-V 1/2" barra di estensione: 125.250 mm; 1 pz Cr-V 1/2" adattatore a 3 vie; 2 prese per candele Cr-V: 16,21mm; 1 adattatore per punte Cr-V: 1/2" * 38 mm
 1 impugnatura a cricchetto a due componenti, 72
 T: 1/4"; 13 prese metriche standard 1/4" Cr-V: 4,4,5,5,5,6,7,8,9,10,11,12,13,14 mm; 8 prese metriche profonde 1/4" Cr-V: 6,7,8,9,10,11,12,13mm; 2 pz Cr-V 1/4" barra di estensione: 50.100 mm; 1 pz Cr-V 1/4" giunto cardanico; 1 pz Cr-V 1/4" barra scorrevole 115 mm; 1 pz barra flessibile 150 mm; 1 pz presa maniglia 150 mm; 17 pz presa bit (materiale S2 dei bit): SL4, SL5.5, SL7, PH1, PH2, PZ1, PZ2, T8, T10, T15, T20, T25, T30, H3, H4, H5, H6 1pz 1/4" adattatore bit S2; 15 punte Cr-V: 8*30 mm SL8, SL10, SL12 mm, PH, PH4 PZ3, PZ4



Codice	Misura	Pz/Conf	Master
15145T	1/4" - 1/2"	1	3

SET 14PZ CRICCHETTO REVERSIBILE CON BUSSOLE DA 1/4"

INDUSTRIAL



GRIPPro series

14 pezzi contiene: 12 prese metriche Cr-V: 4,5,5,5,6,7,8,9,10,11,12,13,14 mm
1 barra di estensione: 50 mm 1 maniglia a cricchetto bicomponente, 72T, sgancio rapido

Codice	Misura	Pz/Conf	Master
15150T	1/4"	5	20

CHIAVI COMBINATE A CRICCHETTO DA 8 A 19mm

8-10-12-13-14-17-19mm
Cr-V
Cromato, Finitura satinata

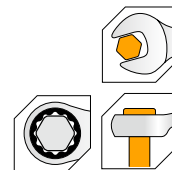

Codice	Misura	Pz/Conf	Master
15229T	8 - 19mm	5	20

SET 12PZ CRICCHETTO REVERSIBILE CON BUSSOLE DA 3/8"

INDUSTRIAL



GRIPPro series

12 pezzi contiene: 10 prese metriche Cr-V: 8,10,11,12,13,14,16,17,18,19 mm
1 barra di prolunga
Cr-V: 75 mm 1 maniglia a cricchetto bicomponente, 72T, sgancio rapido

Codice	Misura	Pz/Conf	Master
15151T	3/8"	5	15

CHIAVI COMBINATE A CRICCHETTO TESTA SNODATA DA 8 A 19mm

8-10-12-13-14-17-19mm
Cr-V
Cromato, Finitura satinata

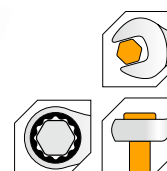

Codice	Misura	Pz/Conf	Master
15259T	8 - 19mm	5	20

SET 12PZ CRICCHETTO REVERSIBILE CON BUSSOLE DA 1/2"

INDUSTRIAL



GRIPPro series

12 pezzi contiene: 10 prese metriche Cr-V: 10,12,13,14,16,17,18,19,21,22 mm
1 barra di prolunga
Cr-V: 75 mm 1 maniglia a cricchetto bicomponente, 72T, sgancio rapido

Codice	Misura	Pz/Conf	Master
15152T	1/2"	5	10

CRICCHETTI REVERSIBILI

CrMo
Finitura antiantimacchia
Manico a cricchetto bicomponente, 72T, ingranaggio Cr-V, sgancio rapido Ideale per l'uso in spazi ristretti



GRIPPro series

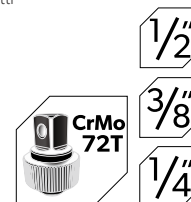

Codice	Misura	Pz/Conf	Master
16118T	1/4"	5	30
16119T	3/8"	5	20
16120T	1/2"	5	20

CHIAVI COMBinate A CRICCHETTO

Cr-V
Cromato, Finitura satinata



Codice	Misura	Pz/Conf	Master
15204T	8mm	10	200
15205T	9mm	10	200
15206T	10mm	10	200
15207T	11mm	10	200
15208T	12mm	10	100
15209T	13mm	10	100
15210T	14mm	10	100
15211T	15mm	10	100
15212T	16mm	10	100
15213T	17mm	10	100
15214T	18mm	10	50
15215T	19mm	10	50
15216T	20mm	10	50
15217T	21mm	10	50
15218T	22mm	5	50
15219T	23mm	5	50
15220T	24mm	5	50
15221T	25mm	5	50
15223T	27mm	5	40
15226T	30mm	5	24
15228T	32mm	5	16

CHIAVI COMBinate A CRICCHETTO TESTA SNODATA

Cr-V
Cromato, Finitura satinata



Codice	Misura	Pz/Conf	Master
15234T	8mm	10	100
15235T	9mm	10	100
15236T	10mm	10	100
15237T	11mm	10	100
15238T	12mm	10	100
15239T	13mm	10	100
15240T	14mm	10	100
15241T	15mm	10	80
15243T	17mm	10	80
15245T	19mm	10	50
15246T	20mm	5	50
15247T	21mm	5	50
15249T	23mm	5	40
15250T	24mm	5	40



CHIAVI COMBinate DIN3113

22 mm
Cr-V
Prodotto secondo DIN3110
Cromato, finitura opaca



Codice	Misura	Pz/Conf	Master
15814T	6mm	12	240
15815T	7mm	12	240
15816T	8mm	12	240
15817T	9mm	12	240
15818T	10mm	12	240
15819T	11mm	12	240
15820T	12mm	12	240
15821T	13mm	12	180
15822T	14mm	12	120
15823T	15mm	12	120
15824T	16mm	12	120
15825T	17mm	6	90
15826T	18mm	6	90

CHIAVI COMBinate DIN3113

22 mm
Cr-V
Prodotto secondo DIN3110
Cromato, finitura opaca



Codice	Misura	Pz/Conf	Master
15827T	19mm	6	90
15828T	20mm	6	90
15829T	21mm	6	60
15830T	22mm	6	60
15831T	23mm	6	60
15832T	24mm	6	48
15833T	25mm	6	48
15834T	26mm	6	48
15835T	27mm	6	48
15836T	28mm	6	30
15837T	29mm	6	30
15838T	30mm	6	30
15839T	32mm	6	30
15840T	35mm	5	20
15842T	38mm	5	20
15843T	41mm	5	10

CHIAVE A CRICCHETTO PER PONTEGGI 19x22mm

19x22mm
Corpo in acciaio speciale per utensili
Presca
Crv a 12 punte
Finitura nera



Codice	Misura	Pz/Conf	Master
15296T	19x22mm	2	32



**SET 8PZ CHIAVI DOPPIA FORCHETTA
6/22mm EX 15076**



INDUSTRIAL



Codice	Misura	Pz/Conf	Master
15891T	6x7/8x9/10x11/12x- 13/14x15/16x-	3	12

SET 5Pz CHIAVI COMBinate 8-19mm

8, 10, 13, 17, 19 mm Cr-V
Prodotto secondo
DIN3110
Cromato, finitura opaca



Codice	Misura	Pz/Conf	Master
15886T	8,10,13,17,19mm	6	24

**SET 8Pz CHIAVI POLIGONALI DOPPIA
CURVA**

Dimensioni:
6x7/8x9/10x11/12x13/14x15/16x17/18x19/20x22mm Cr-V
Prodotto secondo DIN838
Cromato, finitura opaca



INDUSTRIAL



Codice	Misura	Pz/Conf	Master
15895T	6-22mm	3	12

SET 8Pz CHIAVI COMBinate 8/19mm

8, 10, 12, 13, 14, 15, 17, 19 mm Cr-V
Prodotto secondo
DIN3110
Cromato, finitura opaca



INDUSTRIAL



Codice	Misura	Pz/Conf	Master
15887T		6	12

**CHIAVE DINAMOMETRICA CON
PROLUNGA**

Contenuto:
1pz Chiave dinamometrica automatica
Approvata GS ±4% di deviazione di
precisione
Intervallo di coppia: 40-210Nm
1pz Barra di estensione: 1/2"x125mm



INDUSTRIAL



Codice	Misura	Pz/Conf	Master
16010T	28-210nm	1	6

SET 12Pz CHIAVI COMBinate 6/22mm

Prodotto secondo DIN3110
Cromato, finitura opaca



INDUSTRIAL

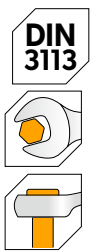

Codice	Misura	Pz/Conf	Master
15888T	6,7,8,9,10,11,12,13,14 ,17,19,22mm	6	12

CHIAVI A BUSSOLA ESAGONALI 1/2"

Materiale: 50BV30,
Trattamento termico,
DIN3124, ISO2725-1
1/2" Driver quadrato secondo
DIN3120, ISO1174, con scanalatura
di ritenzione della sfera
Azionamento manuale, lucidato,
cromato

Codice	Misura	Pz/Conf	Master
16508T	1/2" - 8mm	5	160
16509T	1/2" - 9mm	5	160
16510T	1/2" - 10mm	5	160
16511T	1/2" - 11mm	5	160
16512T	1/2" - 12mm	5	160
16513T	1/2" - 13mm	6	160
16514T	1/2" - 14mm	5	160
16515T	1/2" - 15mm	5	160
16516T	1/2" - 16mm	5	160
16517T	1/2" - 17mm	5	120
16518T	1/2" - 18mm	5	120
16519T	1/2" - 19mm	5	120
16520T	1/2" - 20mm	5	120
16521T	1/2" - 21mm	5	120
16522T	1/2" - 22mm	5	96
16523T	1/2" - 23mm	5	96
16524T	1/2" - 24mm	5	96
16527T	1/2" - 27mm	4	48
16530T	1/2" - 30mm	3	48
16532T	1/2" - 32mm	3	48

CHIAVI A BUSSOLA ESAGONALI PROLUNGATE 1/2"

Materiale: 50BV30,
Trattamento termico,
Acc.to
DIN3124,
ISO2725-1/2"
Driver quadrato secondo
DIN3120,
ISO1174, con scanalatura di ritenzione
della sfera
Azionamento manuale, lucidato, cromato

Codice	Misura	Pz/Conf	Master
16558T	1/2" - 8mm	5	160
16559T	1/2" - 9mm	5	160
16560T	1/2" - 10mm	5	160
16561T	1/2" - 11mm	5	160
16562T	1/2" - 12mm	5	160
16563T	1/2" - 13mm	5	160
16564T	1/2" - 14mm	5	160
16565T	1/2" - 15mm	5	160
16566T	1/2" - 16mm	5	160
16567T	1/2" - 17mm	5	120
16568T	1/2" - 18mm	5	120
16569T	1/2" - 19mm	5	120
16570T	1/2" - 20mm	5	120
16571T	1/2" - 21mm	5	120
16572T	1/2" - 22mm	6	96
16573T	1/2" - 23mm	5	80
16574T	1/2" - 24mm	5	80
16577T	1/2" - 27mm	4	64
16580T	1/2" - 30mm	3	48
16582T	1/2" - 32mm	3	48

SET 10 PZ CHIAVI A BUSSOLA AD IMPATTO 1/2"

Misure:
10,12,13,14,15,17,19,21,22,24mm
Materiale: CrMo, trattato termicamente
Chimicamente molibdeno per la protezione dalla corrosione
Ideale per avvitatori pneumatici, elettrici manuali



INDUSTRIAL



NEW

Codice	Misura	Pz/Conf	Master
18295T		5	10

SET 10 PZ CHIAVI A BUSSOLA PROLUNGATE AD IMPATTO 1/2"

Misure:
10,12,13,14,15,17,19,21,22,24mm
Materiale: CrMo, trattato termicamente
Chimicamente molibdeno per la protezione dalla corrosione
Ideale per avvitatori pneumatici, elettrici e manuali



INDUSTRIAL



NEW

Codice	Misura	Pz/Conf	Master
18296T		5	10

SET 30PZ CRICCHETTO DA 1/4" CON BUSSOLE E INSERTI MISTI

9 chiavi a bussola da 1/4: 5-6-7-8-9-10-11-12-13 mm
inserti da 25 mm:SL: 3,4,5,6 mm
PH: PH0, PH1, PH2, PH3
PZ: PZ0,PZ1,PZ2,PZ3:
Esagonali: 2, 2,5, 3, 4, 5, 5,5, 6 mm TX: T10, T15, T20, T25, T27, T30,T40
1 barra di prolunga da 3 pollici
1 adattatore da 1/4"
Chiave a cricchetto da 1/4"



Codice	Misura	Pz/Conf	Master
20035T		5	20

SET 3 PZ. CHIAVI A BUSSOLA AD IMPATTO

Misure 17,19,21 mm
Materiale: CrMo, trattato termicamente
Con coperchio di protezione in PP
Superficie con trattamento di ossidazione
Ideale per avvitatori pneumatici, elettrici o manuali
Imballaggio: custodia in plastica



INDUSTRIAL



NEW

Codice	Misura	Pz/Conf	Master
15510T	17/19/21mm	5	20





**PRECISIONE
PROFESSIONALE**

TOLSEN

UTENSILI PER OFFICINE



CARRELLO PIEGHEVOLE PORTATA 150Kg

Omologato
TUV/GS
Capacità di carico: max.150kg
Dimensioni: 735x475x852mm
Dimensioni piano: 735X480mm
Ruote 4" in PP+TPR

Codice	Misura	Pz/Conf	Master
62605T	150kg	1	1
			

**CARRELLO PIEGHEVOLE PORTATA 300Kg CON FRENI**

Omologato
TUV/GS
Capacità di carico: max.300kg
Dimensioni: 900x600x845mm
Dimensioni base: 900x600mm
Ruote da 5" con freno

Codice	Misura	Pz/Conf	Master
62606T	300kg	1	1
			

**CARRELLO PIEGHEVOLE PORTATA 70Kg**

Omologazione
TUV/GS
Portata: max. 70KGS
Dimensioni: 425 * 420 * 980 mm
Dimensioni base: 275x420 mm
Telaio in acciaio tubolare, piastra di base per carichi pesanti, ruote in PP/gomma da 150mm

Codice	Misura	Pz/Conf	Master
62600T	70kg	1	1
			

**CARRELLO PIEGHEVOLE IN ALLUMINIO PORTATA 90KG**

Omologazione GS
Portata max.90kg
Dimensioni:385x245mm.
Peso: 4,8 kg
Struttura in alluminio sciolato, manico telescopico, base pieghevole.

Codice	Misura	Pz/Conf	Master
62602T	90kg	1	1
			



IMBUTO



Diametro: 145 mm
 Con rete in acciaio inossidabile
 Tubo di prolunga: 250 mm

Codice	Misura	Pz/Conf	Master
65230T	145mm	5	50

IMBUTO PE



Diametro superiore: 250 mm / 10"
 Diametro inferiore: 25 mm / 1"

Codice	Misura	Pz/Conf	Master
65232T	250mm	5	48

SET 4 IMBUTI IN PP



2", 3", 4", 5"
 Materiale: PP

Codice	Misura	Pz/Conf	Master
65228T	2" / 3" / 4" / 5"	6	72

OLIATORE CON CANNA FLESSIBILE



300ml
 Corpo in ferro con verniciatura a polvere gialla
 Beccuccio flessibile
 Pompa in ferro robusta con anello di tenuta

Codice	Misura	Pz/Conf	Master
65223T	300ml	5	60

COMPRESSORE 12V 200W



Omologazione CE
 Ingresso: CC 12V
 Massimo. Potenza: 200w
 Flusso d'aria: 40L/min
 Max.pressione: 100 PSI (7Bar)
 Tubo dell'aria da 77 cm
 Cavo accendisigari da 2,75 m
 Con LED
 Tre adattatori

NEW

2X
 CYLINDER

Codice	Misura	Pz/Conf	Master
65516T	12V 200W 40l/min	1	6

CAVI DI AVVIAMENTO 220A



16mm², 220A
 Lunghezza: 3M

OMOLOGATO
 GS

Codice	Misura	Pz/Conf	Master
65601T	3mt	5	10

TAPPETO DEFATICANTE SET 4PZ

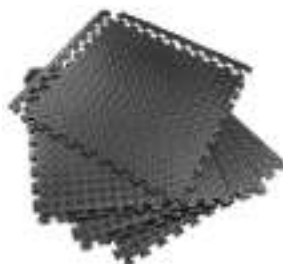

Spessore: 10 mm
 Schiuma EVA di alta qualità
 Ecologico, approvato RoHS
 Lati collegabili ad incastro
 Antiscivolo



Codice	Misura	Pz/Conf	Master
65497T	600x600mm	1	10

TAPPETO DEFATICANTE ROTOLO



Schiuma EVA di alta qualità
 Ottimo per l'uso in officine e garage per fornire condizioni di lavoro confortevoli e prevenire lesioni

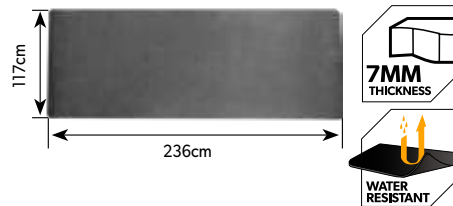

Codice	Misura	Pz/Conf	Master
65499T	117x236cm	1	6

ASTA CON ARPIONE E LUCE LED

Dimensioni: 24"/610 mm
 Con luce LED, 3xAG13/LR44
 Asta flessibile, finitura nera
 dimensione dell'artiglio: 1,5x0,6 mm
 Capacità massima di presa: 750 g
 Diametro massimo di presa: 25 mm
 Capacità di tenuta magnetica: 2 libbre
 Manico in alluminio

NEW

Codice	Misura	Pz/Conf	Master
66020T		6	72
			

INDUSTRIAL

CONTENITORE MAGNETICO PER MINUTERIA

Dimensioni: 150 mm / 6"
 Acciaio inossidabile
 Base magnetica rivestita in gomma
 Ideale per riporre dadi, bulloni, viti, ecc

NEW

Codice	Misura	Pz/Conf	Master
66030T		6	36
			

LENTE DI INGRANDIMENTO 4X



Ingrandimento: 4x
 Diametro della lente: 75mm / 3"
 Dimensioni complessive: 190x85 mm
 Impugnatura di facile presa



NEW

Codice	Misura	Pz/Conf	Master
50011T	4X sez.75mm	12	48
			

PENNA TELESCOPICA CON MAGNETE



Forza magnetica 8LBS 3,629 Kg
 Telescopio da 5-1/2" a 28" (140-705 mm)
 Tubo in acciaio inossidabile
 Imballaggio: blister

NEW

Codice	Misura	Pz/Conf	Master
66001T		12	120
			

LAMPADA DA OFFICINA 50W - 10mt



Omologazione CE
 Potenza massima in ingresso: 60 W
 Tensione nominale: 220-240 V
 Frequenza: 50-60 HZ
 Spina e cavo: approvato VDE 10 m
 Base lampada: E27
 Gancio e riflettore zincati



Codice	Misura	Pz/Conf	Master
60051T	50wx10mt	5	15
			

SET 2PZ MAGNETE E SPECCHIO TELESCOPICI



1 pz Strumento di prelievo magnetico flessibile
 Con luce LED: 3 * 1,5 V LR44
 Forza magnetica: 5LBS (2,268 Kg)
 Telescopio da 245 a 800mm
 Tubo in acciaio inossidabile
 1 pz Specchio di ispezione flessibile
 Diametro dello specchio: 50 mm
 Telescopio da 240 a 700mm
 Tubo in acciaio inossidabile
 Confezione: blister



NEW

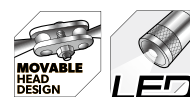

Codice	Misura	Pz/Conf	Master
66005T		10	50
			

UTENSILI DI FISSAGGIO



CACCIAVITI FISSI



Impugnatura confortevole
bicomponente
Punta magnetica con finitura nera



GRIPPro
series



Codice	Misura	Pz/Conf	Master
20001T	3X75	12	144
20002T	4X100	12	144
20003T	5,5X100	12	144
20144T	6,5X100	12	72
20004T	6,5X150	12	72
20005T	8X150	12	72

CACCIAVITI POZIDRIV



Impugnatura confortevole
bicomponente
Punta magnetica finitura nera



GRIPPro
series



Codice	Misura	Pz/Conf	Master
20010T	PZ0X75	12	144
20011T	PZ1X100	12	144
20164T	PZ2X100	12	72
20012T	PZ2X150	12	72
20013T	PZ3X150	12	72

CACCIAVITI MINI PH



Impugnatura confortevole
bicomponente
Punta magnetica finitura nera



GRIPPro
series



Codice	Misura	Pz/Conf	Master
20133T	PH1X38	12	144
20134T	PH2X38	12	144

CACCIAVITI PH



Impugnatura confortevole
bicomponente
Punta magnetica finitura nera



GRIPPro
series



Codice	Misura	Pz/Conf	Master
20006T	PH0X75	12	144
20007T	PH1X100	12	144
20154T	PH2X100	12	72
20008T	PH2X150	12	72
20009T	PH3X150	12	72

CACCIAVITI MINI FISSI



Impugnatura confortevole
bicomponente
Punta magnetica con finitura nera



GRIPPro
series



Codice	Misura	Pz/Conf	Master
20131T	5,5X38	12	144
20132T	6,5X38	12	144

SET 19 PZ CACCIAVITI ASSORTITI + INSERTI



7 cacciaviti
Cr-V SL1.2x6x38, 0.5x3.0x7,
1.0x5.5x100, PH2x38, PH0x75,
PH1x100, PH2x100
4 cacciaviti di precisione SL2.0x50,
SL2.5x50, PH000x50, PH00x50
7 punte Cr-V 1/4"x25mm
SL4, SL6, PH1, PH2, T10, T15, T20
cacciavite per dadi

GRIPPro
series

NEW

Codice	Misura	Pz/Conf	Master
20183T		1	8

SET 44PZ CACCIAVITI ASSORTITI + CHIAVINI ESAGONALE + INSERTI



Lama Cr-V
Impugnatura confortevole bicomponente
Punta magnetica con finitura nera
SL: 0.5x3.0x75mm, 0.8x4.0x100mm, 1.0x5.5x100mm,
1.2x6.5x100mm, 1.6x8.0x150mm
PH: PH0x75mm, PH1x100mm, PH2x100mm,
PH3x150mm PZ: PZ0x75mm, PZ1x100mm,
PZ2x100mm, PZ3x150mm TORX: T10x3.0x75mm,
T15x3.5x75mm, T20x4.0x100mm, T25x4.5x100mm,
T30x5.5x125mm
QUADRATO: S1x5x75mm, S2x6x100mm
Cacciavite a cricchetto 1pc 72 denti, impugnatura
comoda bicomponente
Cacciaviti di precisione 8 pezzi
Materiale Cr-V
Cromato
Impugnatura confortevole bicomponente
Punta magnetica con finitura nera
SL: 2,0x0,4x50 mm, 2,5x0,4x50 mm

GRIPPro
series

NEW

Codice	Misura	Pz/Conf	Master
20184T		1	6

SET 100 PZ CACCIAVITI ASSORTITI+INSERTI + BUSSOLE



Lama Cr-V
Impugnatura confortevole bicomponente
Punta magnetica con finitura nera
SL: 0,5 x 3,0 x 75 mm, 0,8 x 4,0 x 100 mm, 1,0 x 5,5 x 100
mm, 1,2 x 6,5 x 100 mm, 1,6 x 8,0 x 150 mm
PH: PH0x75mm, PH1x100mm, PH2x100mm, PH3x150mm
PZ: PZ0x75mm, PZ1x100mm, PZ2x100mm, PZ3x150mm
TORX: T10x3.0x75mm, T15x3.5x75mm, T20x4.0x100mm,
T25x4.5x100mm, T30x5.5x125mm
QUADRATO: S1x5x75mm, S2x6x100mm
1 cacciavite a cricchetto 72 denti, impugnatura comoda
bicomponente
Cacciaviti di precisione 8 pezzi
Materiale Cr-V
Cromato
Impugnatura confortevole bicomponente
Punta magnetica con finitura nera
SL: 2,0x0,4x50 mm, 2,5x0,4x50 mm

GRIPPro
series

NEW

Codice	Misura	Pz/Conf	Master
20185T		1	4

SET 6PZ CACCIAVITI MISTI



Dimensioni
Cr-V: 5.5*100, 6.5*150,
PH1*100,
PH2*150,
PZ1*100,
PZ2*150mm
Impugnatura confortevole
bicomponente

GRIPPro
series

Punta magnetica con finitura nera



Codice	Misura	Pz/Conf	Master
20014T	5.5*100, 6.5*150, PH1*100,	10	20

CACCIAVITI TORX



Cr-v
T5x3.0x75mm
Impugnatura confortevole
bicomponente
Punta magnetica finitura nera

GRIPPro
series



Codice	Misura	Pz/Conf	Master
20166T	T5*3.0*75	12	144
20167T	T6*3.0*75	12	144
20168T	T7*3.0*75	12	144
20169T	T8*3.0*75	12	144
20170T	T9*3.0*75	12	144
20171T	T10*3.0*75	12	144
20172T	T15*3.5*75	12	144
20173T	T20*4.0*100	12	144
20174T	T25*4.5*100	12	144
20175T	T27*5.0*100	12	144
20176T	T30*5.5*125	12	72
20177T	T40*7.0*125	12	72

SET 4 PZ CACCIAVITI MISTI



Dimensioni
CrV:
SL0.8*4.0*100mm
SL1.2*6.5*100mm
PH1*100mm
PH2*100mm
Impugnatura confortevole
bicomponente
Punta magnetica con finitura
nera

GRIPPro
series



Codice	Misura	Pz/Conf	Master
20179T		10	20

SET 6PZ CACCIAVITE DI PRECISIONE



SL: 1.5x0.25x50mm,
2.0x0.4x50mm, 2.5x0.4x50mm,
PH: PH000x50mm, PH00x50mm,
PH0x50mm
Magnetizzatore per cacciavite 1pz
52x20x12,6 mm
1 foglio magnetico morbido
Φ120x1mm (con colla su un lato,
magnetico sull'altro lato)
Materiale: CR-V
Impugnatura ergonomica con testa
rotante 360 gradi



NEW GRIPPro series



Codice	Misura	Pz/Conf	Master
20193T	1.2x0.25x50 2.0x0.4x50, 2.5x0.4x50, PH000, PH00, PH0	10	40

SET 6PZ CACCIAVITE DI PRECISIONE ECO LINE



1.4x0.05, 2.0x0.5, 2.4x0.6, 3.0x0.6
, P H0, PH1



Codice	Misura	Pz/Conf	Master
20031T		10	100

MAGNETIZZATORE PER CACCIAVITI



Materiale: PP

Codice	Misura	Pz/Conf	Master
20032T		5	96

CACCIAVITE A CRICCHETTO CON 7 INSERTI



1pz impugnatura a cricchetto
7pz punte da 25mm:
4,5,6,PH0,PH1,PH2,PH3mm
Materiale:
Cr-V



Codice	Misura	Pz/Conf	Master
20033T		6	48

SET 26PZ CACCIAVITE A CRICCHETTO CON INSERTI E PROLUNGA



Impugnatura a cricchetto 1pz
Portainseri 1pz: 60mm 25mm
Punte
Cr-v:
SL:4,5,6,7mm
PH:
PH0,PH1,PH2,PH3
PZ:PZ0,PZ1,PZ2,PZ3
HEX:2,2.5,3,4,5,6mm
TX:T10,T15,T20,T25,T30,T40



Codice	Misura	Pz/Conf	Master
20034T		5	20

SET 41PZ CACCIAVITE IMPUGNATURA T CON INSERTI E BUSSOLE



1pz cambio rapido impugnatura a
T 1pz adattatore 25mm
Cr-v 1pz barra di estensione 140mm 6Pz
bussole:5,6,7,8,10,12mm 32Pz 25mm
punte
Cr-v:
SL:3,4,5,6,7mm
PH: 2XPH0,2XPH1,3XPH2,2XPH3
PZ:PZ0,PZ1,PZ2,PZ3
HEX:2,3,4,5,6mm
TX:T8,T9,T10,T15,T20,T25,T27,T30,T40



Codice	Misura	Pz/Conf	Master
20036T		5	20

CACCIAVITE A CRICCHETTO PIEGHEVOLE CON 14 INSERTI



1pz
Cacciavite a cricchetto 1pz
Cacciavite 60mm 12pz punte (6,35x25mm)
SL: 5, 6, 7mm
PH1,
PH2,
PH3
TX:
T10,
T15,
T20
HEX:
H4,
H5,
H6



Codice	Misura	Pz/Conf	Master
20040T		6	36

CACCIAVITE 6 IN 1



2 pezzi di bit a due vie :6,35 *
65 mm, PH1 + SL5 8,00 * 75
mm,
PH2 +
SL6 2 pezzi:6 mm,8mm
Materiale:CR-V
Con 1 manico intercambiabile
Confezionato in doppio blister



Codice	Misura	Pz/Conf	Master
20043T		10	60

SET 42PZ CACCIAVITE A CRICCHETTO CACCIAVITE DI PRECISIONE



1pz
Cacciavite a cricchetto 16pz
Punte (6.35x25mm)
SL: 3,4,5,6mm
PH0,
PH1,
PH2,
PH3
TX:
T10,
T15,
T20,
T25
S0,
S1,
S2,
S3 1pz
Adattatore 25mm 1pz
Cacciavite di precisione 1pz
Magnetico



Codice	Misura	Pz/Conf	Master
20041T		5	20

SET 17PZ CACCIAVITE CON INSERTI E BUSSOLE



Cacciavite per dadi 1/4" x 100 mm 10 punte
CrV: 1/4" x 25 mm
PH1,
PH2,
PH3,
PZ1,
PZ2,
PZ3,
SL4,
SL5,
SL6, adattatore per presa da 1/4" 6 bussole
da 1/4" 5 mm, 6mm, 7mm, 8mm, 9mm,
10mm



Codice	Misura	Pz/Conf	Master
20045T		10	60

CACCIAVITE 2 IN 1



Dimensioni lama a due vie:
6,35X160 mm
PH2 + SL6 * 1,2 mm
Materiale: CR-V
Con impugnatura
intercambiabile



Codice	Misura	Pz/Conf	Master
20042T		10	120

SET 32pz CACCIAVITE DI PRECISIONE CON INSERTI



Contiene: 1 manico per cacciavite di
precisione 1 pz barra di prolunga da 115
mm 30 pz 4x28 mm punte CrV
SL: 1.0, 1.5, 2.0, 2.5, 3.0, 3.5, 4.0 mm
PH: PH000, PH00, PH0, PH1 PZ:
PZ0, PZ1
HEX: 0.7, 0.9, 1.3, 1.5, 2.0, 2.5, 3.0,
4.0 mm
TX: T4, T5, T6, T7, T8,

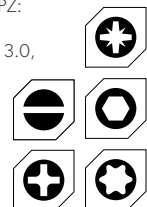

Codice	Misura	Pz/Conf	Master
20047T		5	60

SET 33pz INSERTI MAGNETICI CON PORTAININSERTI



Contiene: 1pz 1/4"x60mm
portaininserti magnetico 32 Cr-V
1/4"x25mm bit: 9pz
Torx con foro:
T8, T10, T15,
T20, T25, T27,
T30, T35, T40
6pz Esagonali
con foro: H2,
H2.5, H3, H4,
H5, H6



Codice	Misura	Pz/Conf	Master
20369T		6	48

SET 15PZ INSERTI MISTI E PORTAININSERTI



Finitura satinata 1 pz 1/4 "x60 mm
porta punte per cacciavite
14 pezzi 6,35 x 25 mm S2
Dimensioni punte: SL5,
SL6, SL7, PH1, PH2,
PH3, PZ1, PZ2, PZ3,
T10, T15, T20, T25, T30



Codice	Misura	Pz/Conf	Master
20365T		16	96

SET 10 PZ CACCIAVITI MISTI



SL3.0x75mm
SL5.5x100mm
SL6.5x100mm
SL6.5x38mm
SL8.0x150mm
PH0x75mm
PH1x100mm
PH2x100mm
PH2x38mm
PH3x150mm



Codice	Misura	Pz/Conf	Master
20740T		6	12

SET 8Pz CACCIAVITI MISTI



SL3.0x75mm
SL5.5x100mm
SL6.5x150mm
SL6.5x38mm
PH0x75mm
PH1x100mm
PH2x150mm
PH2x38mm
Materiale lama: 40Cr
Impugnatura ergonomica



Codice	Misura	Pz/Conf	Master
20739T		5	20

SET 9PZ CHIAVINI ESAGONALI CON SFERA



Set di chiavi esagonali a sfera da 9 pezzi (M)
 Materiale: Cr-v
 1,5/2/2,5/3/4/5/6/8/10 mm
 Trattato termicamente, cromato



Codice	Misura	Pz/Conf	Master
20053T		6	36

SET 9PZ CHIAVINI ESAGONALI CON SFERA EXTRA-LUNGHI



Set di chiavi esagonali a sfera da 9 pezzi (L)
 Materiale: Cr-v
 1,5/2/2,5/3/4/5/6/8/10 mm
 Trattato termicamente, cromato



Codice	Misura	Pz/Conf	Master
20054T		6	36

SET 9PZ CHIAVINI TORX CON FORO EXTRA-LUNGHI



Set di chiavi esagonali torx da 9 pezzi (L)
 Materiale: Cr-v
 T10-T50
 Trattato termicamente, cromato



Codice	Misura	Pz/Conf	Master
20057T	T10 a T50	6	36

SET 9PZ CHIAVINI TORX CON FORO



Set di chiavi esagonali torx da 9 pezzi (M)
 Materiale: Cr-v
 T10-T50
 Trattato termicamente, cromato

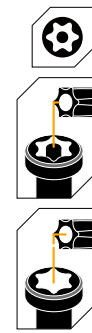

Codice	Misura	Pz/Conf	Master
20056T	T10 a T50	6	36

SET 8pz CHIAVINI ESAGONALI



Set di chiavi esagonali a braccio lungo 9 pezzi (M)
 Materiale: Cr-v
 1,5/2/2,5/3/4/5/6/8/10 mm
 Trattato termicamente, cromato



Codice	Misura	Pz/Conf	Master
20048T		6	36

SET 8pz CHIAVINI ESAGONALI EXTRA LUNGHI



Set di chiavi esagonali a braccio lungo 9 pezzi (L)
 Materiale: Cr-v
 1,5/2/2,5/3/4/5/6/8/10 mm
 Trattato termicamente, cromato



Codice	Misura	Pz/Conf	Master
20049T		6	36

SET 10PZ CHIAVINI ESAGONALI LINEA ECO



1,5/2/2,5/3/4/5/5,5/6/8/10 mm



Codice	Misura	Pz/Conf	Master
20051T		20	80

SET 7 PZ CACCIAVITI A BUSSOLA



Misure: 6mm-7mm-8mm-9mm-10mm-11mm-12mm
 Lunghezza totale: 85 mm
 Impugnatura bicomponente

GRIPre series



Codice	Misura	Pz/Conf	Master
20196T	6,7,8,9,10,11,12 mm	3	12

CARTELLA 8pz CHIAVINI TORX CON IMPUGNATURA A T



T10x75mm
T15x75mm
T20x100mm
T25x100mm
T30x150mm
T40x150mm
T45x200mm
T50x200mm



Codice	Misura	Pz/Conf	Master
20061T	T10 a T50	5	20

CARTELLA 8pz CHIAVINI ESAGONALI CON SFERA E IMPUGNATURA A T



H2.0x100mm
H2.5x100mm
H3.0x100mm
H4.0x150mm
H5.0x150mm
H6.0x200mm
H8.0x200mm
H10.0x200mm



Codice	Misura	Pz/Conf	Master
20062T		5	20

SET INSERTI A BUSSOLA



Acciaio 40Cr da 6 mm
Con punte esagonali magnetiche a sgancio rapido da 1/4"
Lunghezza: 65 mm

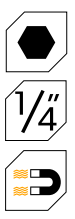

Codice	Misura	Pz/Conf	Master
77841T	1/4" - 6mm	5	100
77843T	1/4" - 8mm	5	100
77845T	1/4" - 10mm	5	100
77848T	1/4" - 13mm	5	100

SET 8PZ CHIAVINI ESAGONALI CON SFERA EX 20058T



Materiale:
Cr-V 1,5-2-2,5-3-4-5-6-8 mm
Trattato termicamente, cromato



Codice	Misura	Pz/Conf	Master
20068T	1,5-2-2,5-3-4-5-6-8	10	60

SET 8PZ CHIAVINI TORX CON FORO TASCABILE EX 20059T



Materiale:
Cr-V
T9-T10-T15-T20-T25-T27-T30-T40
Trattato termicamente, cromato



Codice	Misura	Pz/Conf	Master
20069T	T9-T10-T15-T20-T25-T27-T30-T40	10	60

SET 2PZ PORTAINSERTI MAGNETICI



Materiale da 60 mm: acciaio + CV

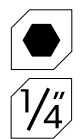

Codice	Misura	Pz/Conf	Master
77861T	60mm	25	100

PORTAINSERTI MAGNETICO CON SGANCIO RAPIDO 60mm



60mm
Materiale:
Cr-V + acciaio inossidabile + alluminio

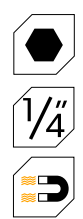

Codice	Misura	Pz/Conf	Master
77863T	60mm	25	100

PORTAINSERTI DA 1/2" A 1/4



Codice	Misura	Pz/Conf	Master
77868T	1/4"x1/2"	10	100

INDUSTRIAL

INSERTI 25mm A TAGLIO



2PCS
Acciaio industriale
S2, temprato e temperato con
finitura satinata



Codice	Misura	Pz/Conf	Master
20202T	SL0,5X4,0X25mm	10	320
20203T	SL0,6X4,5X25mm	10	320
20205T	SL0,8X5,5X25mm	10	320
20207T	SL1,2X6,5X25mm	10	320

INSERTI 25mm PHILLIPS



2PCS
S2 in acciaio industriale, temprato
e temperato con finitura satinata
Punta antiscivolo

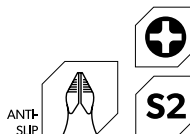

Codice	Misura	Pz/Conf	Master
20212T	PH1X25mm	10	320
20213T	PH2X25mm	10	320
20214T	PH3X25mm	10	320

INSERTI 25mm POZIDRIV



2PCS
S2 in acciaio industriale, temprato
e temperato con finitura satinata
Punta antiscivolo

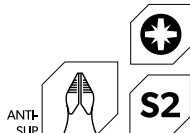

Codice	Misura	Pz/Conf	Master
20217T	PZ1X25mm	10	320
20218T	PZ2X25mm	10	320
20219T	PZ3X25mm	10	320

INSERTI 25mm TORX



2PCS
S2 in acciaio industriale, temprato
e temperato con finitura satinata



Codice	Misura	Pz/Conf	Master
20221T	T10X25mm	10	320
20222T	T15X25mm	10	320
20223T	T20X25mm	10	320
20224T	T25X25mm	10	320
20225T	T27X25mm	10	320
20226T	T30X25mm	10	320
20227T	T40X25mm	10	320

INSERTI 25mm ESAGONALI



2PCS
S2 acciaio industriale, temprato
e temperato con finitura satinata



Codice	Misura	Pz/Conf	Master
20233T	H3X25mm	10	320
20234T	H4X25mm	10	320
20235T	H5X25mm	10	320
20236T	H6X25mm	10	320

SET 5Pz INSERTI MISTI A TAGLIO 25mm

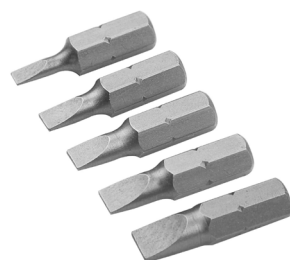

SL3.0-4.0-4.5-5.5-6.5x25mm
Acciaio industriale
S2, temprato e temperato
Finitura satinata

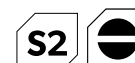

Codice	Misura	Pz/Conf	Master
20285T	SL3.0-4.0-4.5-5.5-6.5x25mm	10	160

SET 5Pz INSERTI MISTI PHILLIPS 25mm



PH0-PH1-PH2x2-PH3x25mm
Acciaio industriale
S2, temprato e temperato
Finitura satinata
Punta antiscivolo

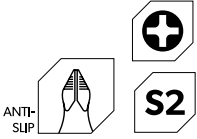

Codice	Misura	Pz/Conf	Master
20286T	PH0-PH1-PH2x2-PH3x25mm	10	160

INSERTI 50mm TORX



2PCS
S2 in acciaio industriale, temprato e temperato con finitura satinata



Codice	Misura	Pz/Conf	Master
20321T	T10X50mm	10	320
20322T	T15X50mm	10	320
20323T	T20X50mm	10	320
20324T	T25X50mm	10	320
20325T	T27X50mm	10	320
20326T	T30X50mm	10	320
20327T	T40X50mm	10	320

INSERTI 50mm ESAGONALI

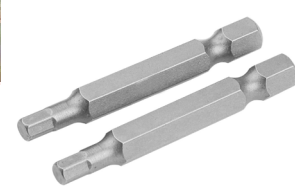

2PCS
S2 in acciaio industriale, temprato e temperato con finitura satinata



Codice	Misura	Pz/Conf	Master
20333T	H3X50mm	10	320
20334T	H4X50mm	10	320
20335T	H5X50mm	10	320
20336T	H6X50mm	10	320

INSERTI 50mm A TAGLIO

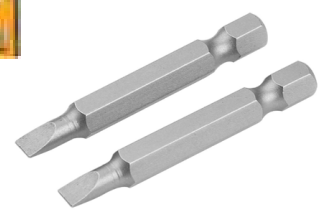

2PCS
Acciaio industriale
S2, temprato e temperato con finitura satinata



Codice	Misura	Pz/Conf	Master
20302T	SL0,5X4,0X50mm	10	320
20303T	SL0,6X4,5X50mm	10	320
20305T	SL0,8X5,5X50mm	10	320
20307T	SL1,2X6,5X50mm	10	320

INSERTI 50mm PH



2PCS
S2 in acciaio industriale, temprato e temperato con finitura satinata
Punta antiscivolo

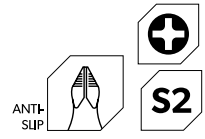

Codice	Misura	Pz/Conf	Master
20312T	PH1X50mm	10	320
20313T	PH2X50mm	10	320
20314T	PH3X50mm	10	320

INSERTI 50mm POZIDRIV



2PCS
S2 in acciaio industriale, temprato e temperato con finitura satinata
Punta antiscivolo

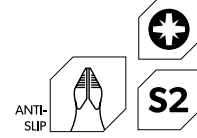

Codice	Misura	Pz/Conf	Master
20317T	PZ1X50mm	10	320
20318T	PZ2X50mm	10	320
20319T	PZ3X50mm	10	320

SET 32 PZ INSERTI MISTI CON PORTAINSERI

1 portapunte per cacciavite da 1/4" x 65 mm
 con magnete potente 30 punte
 S2 da 1/4" x 25 mm
 PH:
 PH1, PH2, PH, PH3
 PZ:
 PZ1, PZ2, PZ2, PZ3
 SL: 3-4-5-6
 Hex:
 H3-H4-H5-H6
 Torx:
 T10-T15-T20-T25-T27-T30-T40
 Torx (con foro):
 T10-T15-T20-T25-T27-T30-T40 1pz 1/4"*25mm

Codice	Misura	Pz/Conf	Master
20370T		6	48
			



INDUSTRIAL

SET 26 PZ CACCIAVITE A CRICCHETTO

1 cacciavite a cricchetto con impugnatura bicomponente
 18 punte Cr-V da 65 mm
 PH0, PH1, PH2, PH3,
 PZ1, PZ2, PZ3,
 SL3, SL4, SL5, SL6, SL7,
 T10, T15, T20, T25, T27, T30
 Chiavi a bussola 6 pezzi 1/4"x38mm:
 5mm, 6mm, 7mm, 8mm, 9mm, 10mm
 1 portainseri Cr-V 1/4"x60mm
 Imballo: sacchetto in tela con blister

Codice	Misura	Pz/Conf	Master
20186T		5	20
			



GRIPPro series

NEW



INDUSTRIAL



SET 56 PZ CACCIAVITE A CRICCHETTO

1 cacciavite a cricchetto con impugnatura bicomponente
 21 punte Cr-V, H6x25mm
 SL4, SL5, SL6
 PH1, PH2, PH3
 PZ1, PZ2, PZ3
 H3, H4, H5, H6
 T10, T15, T20, T25, T27, T30, T35, T40
 20 punte Cr-V, H4x28mm
 SL1.5, SL2, SL2.5, SL3.0
 PH000, PH00, PH0
 PZ000, PZ00, PZ0
 T5, T6, T7, T8, T9, T10
 H0.9, H1.3, H1.5, H2.0
 9 bussole da 1/4" Sq, Dr, Cr-V, 4, 5, 6, 7, 8, 9, 10, 11, 12 mm
 1 portainseri Cr-V 1/4"x60mm
 Driver per punte di precisione
 1 barra di prolunga per punte di precisione da 75 mm
 Adattatore 1pc 1/4" x25mm
 Custodia in plastica con rivestimento in TPR, antiscivolo

Codice	Misura	Pz/Conf	Master
20187T		3	12
			

GRIPPro series

NEW



SET 105 PZ CACCIAVITE A CRICCHETTO

1 cacciavite a cricchetto bicomponente
 1 adattatore per punte Cr-V 1/4"x26mm
 1 portainseri Cr-V 1/4"x60mm
 Adattatore presa 1pc 1/4"x50mm
 Adattatore presa 1pc 1/4"x25mm
 100 punte Cr-V 1/4"x25mm
 4 pezzi SL: 3, 4, 5, 6 mm
 11 pz PH: 2xPH0, 2xPH1, 5xPH2, 2xPH3
 10 pezzi PZ: PZ0, 2xPZ1, 5xPZ2, 2xPZ3
 13 Torx: T8, 2xT10, 2xT15, 2xT20, 2xT25, T27, T30, T40, T45
 9 pezzi esagonali: 1, 5, 2, 2, 5, 3, 4, 4, 5, 5, 5, 5, 6
 10 pezzi esagonali SAE: 1/16", 5/64", 3/32", 7/64", 1/8", 9/64", 5/32", 3/16", 7/32", 1/4"
 3 pezzi tipo M: 5, 6, 8
 4 quadrati: 0, 1, 2, 3
 4 pezzi tipo U: 4-6-8-10
 Tipo TORO 3 pezzi: 6, 8, 10
 Tipo TR da 4 pezzi: 1, 2, 3, 4
 9 pezzi Torx con fori: T8, T10, T15, T20, T25, T27, T30, T40, T45
 12 pezzi esagonali con fori: 2, 2, 5, 3, 4, 5, 6, 5/64", 3/32",

Codice	Misura	Pz/Conf	Master
20188T		3	12
			

GRIPPro series

NEW

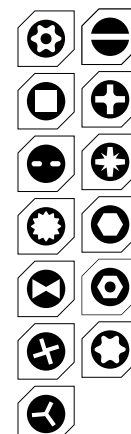

RIVETTATRICE MANUALE DA 250mm



Corpo in acciaio temprato
Rivetto applicabile: chiave per ugelli in dotazione da 2,4,3,2,4,0,4,8mm

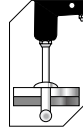

	2.4mm (3/32")	3.2mm (1/8")	4mm (5/32")	4.8mm (3/16")
Aluminium	•	•	•	•

Codice	Misura	Pz/Conf	Master
43001T	250mm	6	24

RIVETTATRICE COMPATTA CON REGOLAZIONE DELLO SFORZO 190mm



Impugnatura ergonomica in TPR
Tre ganasce, acciaio legato, HRC58-62,
Corsa massima di lavoro: 7 mm
Adatto per rivetti in alluminio applicabili:
2,4 mm (3/32"), 3,2 mm (1/8"), 4 mm
(5/32"), 4,8 mm (3/16"), applicabile con
rivetto in acciaio inossidabile: 2,4 mm
(3/32"), 3,2 mm (1/8"), 4 mm (5/32"),

	2.4mm (3/32")	3.2mm (1/8")	4mm (5/32")	4.8mm (3/16")
Aluminium	•	•	•	•
Steel	•	•	•	
Stainless steel	•	•	•	

Codice	Misura	Pz/Conf	Master
43099T	190mm	1	24

RIVETTATRICE IN ALLUMINIO 240mm

10,5"
Corpo in alluminio
Rivetto applicabile: chiave per ugelli in
dotazione da 2,4,3,2,4,0,4,8 mm

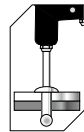

	2.4mm (3/32")	3.2mm (1/8")	4mm (5/32")	4.8mm (3/16")
Aluminium	•	•	•	•

Codice	Misura	Pz/Conf	Master
43003T	240mm	6	24

RIVETTATRICE DIRITTA COMPATTA A LEVA

Corpo in lega di alluminio verniciato a polvere
Maniglia ergonomica salva-lavoro con comode impugnature in PVC
5 naselli sostituibili
Rivetti di supporto:
Rivetto in acciaio inossidabile: 2,4 mm (3/32"), 3,2 mm (1/8"), 4,0 mm
(5/32"), 4,8 mm (3/16"), 6,4 mm (1/4")
Rivetto in ferro: 2,4 mm (3/32"), 3,2 mm (1/8"), 4,0 mm (5/32"),
4,8 mm (3/16"), 6,4 mm (1/4")
Rivetto in alluminio: 2,4 mm (3/32"), 3,2 mm (1/8"), 4,0 mm (5/32"),
4,8 mm (3/16") Una bottiglia di raccolta integrata raccoglie i nuclei
esauriti per problemi di sicurezza e facile smaltimento



	2.4mm (3/32")	3.2mm (1/8")	4mm (5/32")	4.8mm (3/16")	6.4mm (1/4")
Aluminium	•	•	•	•	•
Steel	•	•	•	•	•
Stainless steel	•	•	•	•	

Codice	Misura	Pz/Conf	Master
43096T	325mm	1	12

RIVETTI



Materiale: alluminio
Dimensioni: 2,4x6,4 mm
conf. 50 pz



NEW

x50

Codice	Misura	Pz/Conf	Master
43005T	2.4x6.4mm	10	300
43006T	2.4x8mm	10	300
43007T	3.2x6.4mm	10	250
43008T	3.2x10mm	10	250

RIVETTI



Materiale: alluminio
Dimensioni: 2,4x6,4 mm
conf. 50 pz



NEW

x50

Codice	Misura	Pz/Conf	Master
43009T	4x10mm	10	200
43010T	4x12.7mm	10	200
43011T	4.8x12.7mm	10	150
43012T	4.8x16mm	10	150

PUNTI PER SPILLATRICE

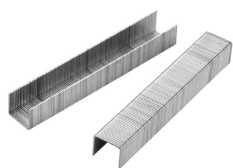

1000 pezzi confezionati in una scatola colorata

Codice	Misura	Pz/Conf	Master
43023T	0.7x6mm	10	200
43024T	0.7x8mm	10	200
43025T	0.7x10mm	10	200
43028T	1.2x8mm	10	100
43029T	1.2x10mm	10	100
43030T	1.2x12mm	10	100

SPILLI PER CHIODATRICE PNEUMATICA



18 GA, 1,25 x 1,0 mm
Testa del chiodo: 2x1,25 mm
Superficie zincata
Confezione: 5000 pezzi

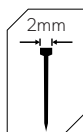

Codice	Misura	Pz/Conf	Master
73443T	25 mm	1	10
73444T	30 mm	1	10
73445T	32mm	1	10
73448T	40mm	1	10
73449T	50 mm	1	10

PUNTI PER CHIODATRICE PNEUMATICA



18 GA, 1,25 x 1,0 mm
Superficie zincata
Confezione: 5000 pezzi

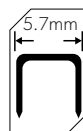

Codice	Misura	Pz/Conf	Master
73455T	25mm	1	6
73456T	30 mm	1	6
73457T	35 mm	1	6
73459T	40mm	1	6

SPILLATRICE PROFESSIONALE 4-14mm



Omologazione GS
Per graffette a filo sottile, 0,7 mm Lunghezza della gamba delle graffette: 4-14 mm (5/32"-9/16")
Pulsante di rilascio rapido dell'inceppamento
Regolazione della potenza dell'impatto
Superficie: Verniciatura
Con 500 graffette a corona da 0,7 x 8 mm

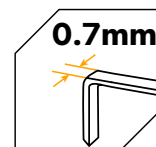

Codice	Misura	Pz/Conf	Master
43020T	4-14mm	6	24

SPILLATRICE / SPARACHIODI MULTIUSO 4-14mm



4-14 mm (5/32"-9/16")
Superficie: rivestimento in vernice
Set con 200 pezzi ciascuno di corona, forma a U, chiodini.
Graffette compatibili: rapid 140, Arrow T50, Arrow T18, Rapid 28, Esco 300

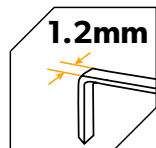

Codice	Misura	Pz/Conf	Master
43021T	4-14mm	6	24

SPILLATRICE MANUALE 4-8mm



4-8 mm(5/32"-5/16")
Superficie:verniciatura
Graffette compatibili:rapid 530, Arrow Jt21

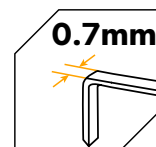

Codice	Misura	Pz/Conf	Master
43022T	4-8mm	5	40

SET 3PZ ADATTATORE ATTACCO ESAGONALE PER CHIAVI A BUSSOLA CON INNESTI



DIN3123
 1/4" * 65mm 3/8" * 65mm
 1/2" * 70mm
 Materiale: 40Cr
 Finitura con sabbiatura



1/4"

3/8"

1/2"

SET 3PZ ADATTATORI SDS-PLUS



Ø 10 mm x 1/4"; Ø 10mm x 3/8"; Ø 10mm x 1/2"
 Materiale: 40Cr
 Lunghezza: 65mm
 Finitura sabbiata

1/4"

3/8"

1/2"

Codice	Misura	Pz/Conf	Master
77864T		5	100

Codice	Misura	Pz/Conf	Master
77865T		5	100



TOLSEN

ACCESSORI PER ELETTROUTENSILI



LAMA OSCILLANTE SEGMENTATA 87.5MM



Diametro: 87,5 mm
 Con trattamento termico
 Superficie verniciata nera con
 foro a sgancio rapido
 Confezione: blister

Codice	Misura	Pz/Conf	Master
76847T	43mm	20	160

SET 4 PZ LAME OSCILLANTI PER UTENSILE MULTIFUNZIONE 79558T



1pz lama 20x65 mm,
 lunghezza totale 90 mm
 1pz lama 32x90mm HSS
 1pz lama raschietto 52x90mm
 1pz lama segmentata diametro
 87,5 mm
 Con trattamento termico
 Superficie verniciata nera
 Confezione blister

Codice	Misura	Pz/Conf	Master
76840T		20	80

LAMA OSCILLANTE 32MM



Larghezza: 32 mm Materiale
 bimetallico HSS Lunghezza
 totale 90 mm Con trattamento
 termico Superficie verniciata
 nera Tipo con foro a sgancio
 rapido Imballaggio: blister

Codice	Misura	Pz/Conf	Master
76845T	32mm	20	160

PLATORELLO PER UTENSILE MULTIFUNZIONE 79558T



Dimensioni: 80x80x80 mm
 Piastra inferiore in acciaio inossidabile
 Imballaggio: blister

Codice	Misura	Pz/Conf	Master
76850T	80x80x80mm	20	160

LAMA OSCILLANTE A RASCHIETTO 52MM



Larghezza: 52 mm (2") lunghezza
 totale 90 mm
 Con trattamento termico
 Superficie verniciata nera Tipo
 con foro a sgancio rapido
 Imballaggio: blister

Codice	Misura	Pz/Conf	Master
76848T	52mm	20	160

SET 10PZ MISTI FOGLI ABRASIVI PER PLATORELLO 76850T



Dimensioni: 80x80x80mm
 Contiene:
 40GR-2 pezzi,
 60GR 2 pezzi,
 80GR- 2 pezzi,
 120GR-2 pezzi,
 240GR-2 pezzi
 Imballaggio: blister

Codice	Misura	Pz/Conf	Master
76852T	80x80x80mm	20	160

PUNTE SDS-PLUS 4 TAGLIENTI



Punta a 4 taglienti TCT di alta qualità
Corpo in acciaio legato al cromo
SDS plus gambo, doppia scanalatura
Finitura con sabbiatura

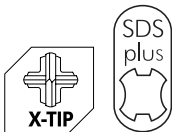

INDUSTRIAL

Codice	Misura	Pz/Conf	Master
74802T	6X110	10	200
74804T	8X110	10	200
74822T	6X160	10	200
74824T	8X160	10	200
74826T	10X160	10	200
74828T	12X160	10	200
74830T	14X160	10	100
74832T	16X160	10	100
74842T	6X210	10	200
74844T	8X210	10	200
74846T	10X210	10	200
74848T	12X210	10	200
74850T	14X210	10	100
74852T	16X210	10	100
74864T	8X260	10	200
74866T	10X260	10	200
74868T	12X260	10	100
74870T	14X260	10	100
74872T	16X260	10	50
74874T	18X260	10	50

PUNTE SDS-PLUS 4 TAGLIENTI



Punta a 4 taglienti TCT di alta qualità
Corpo in acciaio legato al cromo
SDS plus gambo, doppia scanalatura
Finitura con sabbiatura

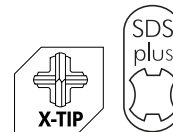

INDUSTRIAL

Codice	Misura	Pz/Conf	Master
74886T	10X310	5	100
74888T	12X310	5	100
74890T	14X310	5	100
74892T	16X310	5	50
74894T	18X310	5	50
74906T	10X450	10	100
74908T	12X450	5	100
74910T	14X450	5	50
74912T	16X450	5	50
74914T	18X450	5	25
74916T	20X450	5	25
74918T	22X450	5	25
74921T	25X450	5	25



PUNTE SDS-PLUS 2 TAGLIENTI



Codice	Misura	Pz/Conf	Master
75301T	5X110mm	10	400
75302T	6X110mm	10	400
75303T	7X110mm	10	320
75304T	8X110mm	10	320
75306T	10X110mm	10	320
75308T	12X110mm	10	240
75317T	5.5X110mm	10	400
75318T	6.5X110mm	10	400
75321T	5X160mm	10	320
75322T	6X160mm	10	320
75323T	7X160mm	10	320
75324T	8X160mm	10	240
75325T	9X160mm	10	240
75326T	10X160mm	10	240
75327T	11X160mm	10	240
75328T	12X160mm	10	160
75329T	13X160mm	10	160
75330T	14X160mm	10	160
75337T	5.5X160mm	10	320

PUNTE SDS-PLUS 2 TAGLIENTI



Codice	Misura	Pz/Conf	Master
75338T	6.5X160mm	10	320
75342T	6X210mm	10	240
75344T	8X210mm	10	240
75346T	10X210mm	10	160
75347T	11X210mm	10	160
75348T	12X210mm	10	160
75349T	13X210mm	10	120
75350T	14X210mm	10	120
75352T	16X210mm	10	80
75362T	6X260mm	10	200
75363T	7X260mm	10	200
75364T	8X260mm	10	160
75365T	9X260mm	10	160
75366T	10X260mm	10	160
75367T	11X260mm	10	160
75368T	12X260mm	10	120
75369T	13X260mm	10	120
75370T	14X260mm	10	80
75372T	16X260mm	10	80

PUNTE SDS-PLUS 2 TAGLIANTI



5X110mm
Corpo in acciaio legato al cromo
SDS plus gambo,
Doppio flauto
Finitura con sabbiatura



Codice	Misura	Pz/Conf	Master
75377T	5.5X260mm	10	200
75384T	8X310mm	10	160
75386T	10X310mm	10	120
75387T	11X310mm	10	120
75388T	12X310mm	10	120
75390T	14X310mm	10	80
75392T	16X310mm	10	60
75394T	18X310mm	10	40
75396T	20X310mm	10	40
75406T	10X450mm	10	80
75408T	12X450mm	10	80
75409T	13X450mm	10	60
75410T	14X450mm	10	60
75412T	16X450mm	10	40
75414T	18X450mm	10	40
75415T	20X450mm	1	30
75416T	22X450mm	1	30
75417T	24X450mm	1	25

PUNTE PER CALCESTRUZZO



3.0x60mm
Punta
TCT di alta qualità
Corpo in acciaio legato al cromo
Gambo tondo, doppia scanalatura
Finitura sabbiata

Codice	Misura	Pz/Conf	Master
75500T	3.0X61mm	10	400
75501T	4.0X75mm	10	400
75502T	4.5X80mm	10	400
75503T	5.0X86mm	10	400
75504T	5.5X93mm	10	400
75505T	6.0X100mm	10	400
75506T	6.5X101mm	10	400
75507T	7.0X109mm	10	320
75508T	8.0X117mm	10	320
75509T	8.5X117mm	10	320
75510T	9.0X125mm	10	320
75511T	10.0X133mm	10	240
75512T	11.0X142mm	10	240
75513T	12.0X151mm	10	240
75514T	13.0X150mm	10	160
75515T	14.0X150mm	10	160
75516T	15.0X150mm	10	160
75517T	16.0X150mm	10	80
75518T	18.0X160mm	5	80
75519T	19.0X160mm	5	80

SCALPELLO SDS-PLUS A PUNTA

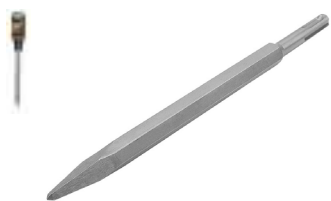

14X250mm, corpo a punta in acciaio legato
Finitura con sabbiatura



Codice	Misura	Pz/Conf	Master
75440T	14X250mm	10	60

SGORBIA SDS-PLUS PER SCALANATURE



17*280*22mm
Corpo in lega di cromo
Finitura con sabbiatura



Codice	Misura	Pz/Conf	Master
75448T	14X250X22mm	10	60

SCALPELLO SDS-PLUS PIATTO

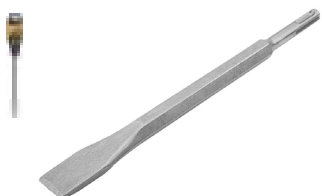

14X250 X 20mm, corpo piatto in lega di cromo
Finitura con sabbiatura



Codice	Misura	Pz/Conf	Master
75441T	14X250X20mm	10	60

SCALPELLO SDS-PLUS PIATTO LARGO



14X250 X 40mm, corpo piatto in lega di cromo
Finitura con sabbiatura



Codice	Misura	Pz/Conf	Master
75442T	14X250X40mm	5	60

SCALPELLO A PUNTA ATTACCO ESAGONALE



30x410mm, a punta
Corpo in acciaio legato al cromo
Finitura sabbiata



Codice	Misura	Pz/Conf	Master
75454T	30x410mm	5	12

SCALPELLO PIATTO ATTACCO ESAGONALE



30x410x35mm, piatto
Corpo in acciaio legato al cromo
Finitura sabbiata



Codice	Misura	Pz/Conf	Master
75455T	30x410x35mm	5	12

SCALPELLO PIATTO ATTACCO ESAGONALE

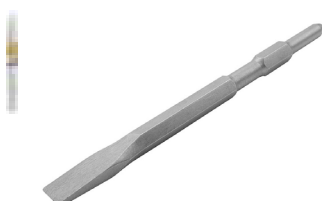

17x280x25mm, piatto
Corpo in acciaio legato al cromo
Finitura con sabbiatura



Codice	Misura	Pz/Conf	Master
75451T	17x280x25mm	5	40

SCALPELLO A PUNTA ATTACCO ESAGONALE



17x280mm, a punta
Corpo in acciaio legato al cromo
Finitura con sabbiatura
Imballo: tubo in plastica



Codice	Misura	Pz/Conf	Master
75450T	17x280mm	5	40

SCALPELLO SDS-MAX A PUNTA 18X400mm



18x400mm, punta
Corpo in lega di cromo
Finitura sabbiata

Codice	Misura	Pz/Conf	Master
75456T	18X400mm	5	30

SCALPELLO SDS-MAX PIATTO 18X400X25mm



18x400x25mm, piatto
Corpo in lega di cromo
Finitura con sabbiatura

Codice	Misura	Pz/Conf	Master
75457T	18X400X25mm	5	30

PUNTE PER MURO



ISO
5468

DIN8039

ISO5468, DIN8039
Punta TCT di alta qualità
Angolo generale 130°
Gambo cilindrico
Superficie cromata
Applicazione in tutte le macchine di perforazione rotative e a percussione Per l'uso in mattoni
Blocchi di muratura
Calcestruzzo leggero

Codice	Misura	Pz/Conf	Master
75460T	3X60mm	10	300
75461T	4X75mm	10	300
75462T	5X85mm	10	300
75463T	6X100mm	10	200
75464T	8X120mm	10	200
75465T	10X120mm	10	160
75466T	12X150mm	10	120
75467T	14X150mm	10	100
75468T	16X150mm	10	80
75475T	5.5X100mm	10	300
75476T	6.5X100mm	10	200
75477T	7X100mm	10	200
75478T	9X120mm	10	160
75479T	13X150mm	10	100

SET 5PZ PUNTE MISTE PER MURO 4-5-6-8-10mm



Set di 5 punte per muratura
Dimensioni: 4X75, 5X85, 6X100, 8X120, 10X120 mm
ISO5468, DIN8039
Punta in metallo duro standard europeo
Angolo generale 130°
Gambo cilindrico
Superficie cromata
Applicazione in tutte le perforatrici rotative e a percussione
Per l'uso in blocchi di muratura in mattoni
Calcestruzzo leggero
Imballaggio : scatola di plastica

Codice	Misura	Pz/Conf	Master
75459T	4-5-6-8-10mm	10	80

PUNTE PER CALCESTRUZZO



Punta TCT di alta qualità
Corpo in acciaio legato al cromo
Gambo tondo, doppia scanalatura
Finitura sabbata

Codice	Misura	Pz/Conf	Master
75520T	200X160mm	5	80
75521T	22X160mm	5	60
75522T	24X160mm	5	60
75523T	25X160mm	5	60

PUNTE PER CALCESTRUZZO EXTRA LUNGHE



Punta TCT di alta qualità
Corpo in acciaio legato al cromo
Gambo tondo, doppia scanalatura
Finitura con sabbatura



Codice	Misura	Pz/Conf	Master
75530T	8x200mm	10	240
75540T	6x300mm	10	120
75541T	8x300mm	10	120
75545T	14x300mm	10	80
75560T	6x400mm	10	80



PUNTE PER MURATURA

SET 19PZ PUNTE FERRO HSS MISTE 1-10mm



HSS,
DIN338 1,1.5,2,2.5,3,3.5,4,4.5,5,5.5,
6,6.5,7,7.5,8,8.5,9,9.5,10mm 118°
Angolo generale
Imballaggio: scatola di ferro con
etichetta a colori

Codice	Misura	Pz/Conf	Master
75081T	1-10mm	6	24

SET 25PZ HSS PUNTE MISTE PER FERRO



HSS,
DIN338 1,1.5,2,2.5,3,3.5,4,4.5,5,5.5,
6,6.5,7,7.5,8,8.5,9,9.5,10,10.5,11,11.5,
12,12.5,13mm 118°
Angolo generale
Imballaggio: scatola di ferro

Codice	Misura	Pz/Conf	Master
75082T	1-13mm	5	10

SET 19pz PUNTE PER FERRO BLACK & GOLD



HSS/M2, DIN338
Acciaio ad alta velocità presenta un gambo dorato e un corpo nero
1,1.5,2,2.5,3,3.5,4,4.5,5,5.5,6,6.5,7,7.5,8,8.5,9,9.5,10mm
Punto di taglio 130°
Gambo a 3 appiattimenti su 5 mm
e oltre per una migliore presa del mandrino

INDUSTRIAL



Codice	Misura	Pz/Conf	Master
75086T	1, 1.5, 2, 2.5, 3, 3.5, 4, 4.5, 5, 5.5, 6, 6.5,	6	24

PUNTE PER FERRO HSS GOLD



HSS/M2, l'acciaio ad alta
velocità DIN338 presenta un
gambo dorato e un flauto nero
118° Punto di divisione 10 pezzi
confezionati in una scatola di
plastica

INDUSTRIAL

SPLIT POINT

Codice	Misura	Pz/Conf	Master
75105T	1.0mm	1	40
75106T	1.5mm	1	40
75107T	2.0mm	1	40
75108T	2.5mm	1	40
75109T	3.0mm	1	40
75110T	3.2mm	1	40
75111T	3.5mm	1	40
75113T	4.0mm	1	40
75115T	4.5mm	1	24
75117T	5.0mm	1	24
75118T	5.5mm	1	24
75119T	6.0mm	1	24
75120T	6.5mm	1	16
75121T	7.0mm	1	16
75122T	7.5mm	1	16
75123T	8.0mm	1	16
75124T	8.5mm	1	16
75125T	9.0mm	1	16
75126T	9.5mm	1	16
75127T	10.0mm	1	16

PUNTE PER FERRO HSS GOLD



HSS/M2, l'acciaio ad alta velocità DIN338 presenta un gambo dorato e un flauto nero
 118° Punto di divisione
 10 pezzi confezionati in una scatola di plastica



SPLIT POINT

Codice	Misura	Pz/Conf	Master
75128T	10.5mm	1	16
75129T	11.0mm	1	16
75130T	11.5mm	1	16
75131T	12.0mm	1	16
75132T	12.5mm	1	16
75133T	13.0mm	1	16

PUNTE PER FERRO A COBALTO



HSS/M35,
 DIN338
 135° Punto di divisione



SPLIT POINT
COBALT+ Co 5%

Codice	Misura	Pz/Conf	Master
75147T	4.5mm	10	80
75174T	4.8mm	10	80
75148T	5.0mm	10	80
75149T	5.5mm	10	80
75150T	6.0mm	10	80
75151T	6.5mm	10	60
75152T	7.0mm	10	60
75153T	7.5mm	10	60
75154T	8.0mm	10	60
75155T	8.5mm	10	60
75156T	9.0mm	10	60
75157T	9.5mm	10	60
75158T	10.0mm	10	60
75159T	10.5mm	5	60
75160T	11.0mm	5	40
75161T	11.5mm	5	40
75162T	12.0mm	5	40
75163T	12.5mm	5	40
75164T	13.0mm	5	40

PUNTE PER FERRO A COBALTO



HSS/M35,
 DIN338
 135° Punto di divisione



SPLIT POINT
COBALT+ Co 5%

Codice	Misura	Pz/Conf	Master
75140T	1.0mm	10	160
75141T	1.5mm	10	160
75142T	2.0mm	10	160
75143T	2.5mm	10	160
75144T	3.0mm	10	160
75172T	3.2mm	10	80
75145T	3.5mm	10	80
75146T	4.0mm	10	80
75173T	4.2mm	10	80

SET 16PZ PUNTE MISTE

6 punte HSS
 TWIST: 2, 3, 4, 5, 6, 8 mm; 5 punte
 per legno: 4, 5, 6, 8, 10 mm; 5 punte
 per muratura: 4, 5, 6, 8, 10 mm;



Codice	Misura	Pz/Conf	Master
75628T		6	24
			

PUNTA FORSTNER 35MM



Dimensioni: 35 mm
 Lunghezza totale: 80 mm
 Diametro gambo: 10 mm
 Lama in TCT
 Corpo forgiato in un unico pezzo
 Imballaggio: scatola di plastica

NEW

Codice	Misura	Pz/Conf	Master
75654T	35mm	5	80
			

SET 5 PZ PUNTE PER VETRO



4,5,6,8,10 mm
 Punta in carburo di alta qualità
 Gambo in acciaio al carbonio n. 45
 Superficie finita con sabbatura
 Imballaggio: custodia in plastica

NEW

Codice	Misura	Pz/Conf	Master
75688T	4,5,6,8,10mm	5	80
			















PUNTE HSS PER FERRO ATTACCO 1/4"

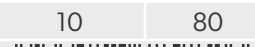

M2
 HSS
 DIN388

HSS/M2,
 DIN338
 Superficie completamente rettificata con
 rivestimento in Titanio
 Punta di spaccatura a 135° Diametro: 3
 mm
 Lunghezza totale: 81 mm
 Gambo esagonale a sgancio rapido da
 1/4"

SPLIT POINT

Codice	Misura	Pz/Conf	Master
75180T	3X81mm	10	80
			
75181T	3.2x85mm	10	80
			
75182T	3.5X90mm	10	80
			
75183T	4X95mm	10	80
			
75184T	4.2X95mm	10	80
			
75185T	4.5x100mm	10	80
			
75186T	4.8x106mm	10	80
			
75187T	5x106mm	10	80
			
75188T	5.5x113mm	10	80
			
75189T	6x113mm	10	80
			
75190T	6.5x121mm	10	60
			
75191T	7x109mm	10	60
			
75192T	8x117mm	10	60
			
75193T	9x125mm	10	60
			
75194T	10x133mm	10	60
			

SET 6PZ PUNTE A FARFALLA PER LEGNO



Dimensioni: 10,12,16,18,20,25 mm
 Acciaio al carbonio temprato
 Con gambo esagonale a sgancio rapido
 da 1/4".
 Lunghezza totale: 152 mm



Codice	Misura	Pz/Conf	Master
75655T	10, 12, 16, 18, 20, 25mm	6	36
			

PUNTE PER LEGNO PIATTE



Acciaio al carbonio temprato e temperato
Lucidato di precisione
Con gambo esagonale a sgancio rapido da 1/4"
Lunghezza totale: 152 mm



Codice	Misura	Pz/Conf	Master
75631T	6mm	12	180
75632T	8mm	12	180
75633T	10mm	12	180
75634T	12mm	12	180
75635T	13mm	12	180
75636T	14mm	12	180
75637T	16mm	12	180
75638T	18mm	12	180
75639T	19mm	12	180
75640T	20mm	12	180
75641T	22mm	12	180
75642T	24mm	12	180
75643T	25mm	12	180
75644T	28mm	12	180
75645T	30mm	12	180
75646T	32mm	12	180
75647T	35mm	12	180
75648T	36mm	12	180
75649T	38mm	12	180
75650T	40mm	12	180

PUNTE PER LEGNO ELICOIDALI



Acciaio al carbonio di alta qualità, DIN338
Temprato e temperato
Finitura nera con superficie lucida

Codice	Misura	Pz/Conf	Master
75600T	3X61mm	10	100
75601T	4X75mm	10	100
75602T	5X86mm	10	100
75603T	6X93mm	10	100
75604T	7X109mm	10	80
75605T	8X117mm	10	80
75606T	9X125mm	10	80
75607T	10X133mm	10	80
75608T	11X142mm	10	60
75610T	13X151mm	10	60

SET 5PZ PUNTE PER LEGNO



4, 5, 6, 8, 10 mm
Acciaio al carbonio di alta qualità, DIN338 temprato e temperato
Finitura nera con superficie lucida

Codice	Misura	Pz/Conf	Master
75625T	4-5-6-8-10mm	10	80

FRESE BI-METALLO



Diametro: 16 mm, 5/8"
 Profondità di taglio: 38 mm
 Materiale: HSS M3
 Bi-metallo
 Denti veri 4-6TPI

4-6TPI

HSS-M3

Codice	Misura	Pz/Conf	Master
75716T	16mm	1	100
75719T	19mm	1	100
75720T	20mm	1	100
75721T	21mm	1	100
75722T	22mm	1	100
75724T	24mm	1	100
75725T	25mm	1	100
75727T	27mm	1	100
75729T	29mm	1	100
75730T	30mm	1	100
75732T	32mm	1	100
75733T	33mm	1	100
75735T	35mm	1	100
75740T	40mm	1	100
75751T	51mm	1	50
75754T	54mm	1	50
75760T	60mm	1	50
75764T	64mm	1	50
75779T	79mm	1	50
75783T	83mm	1	50

SET 11pz FRESE BI-METALLO DA 19mm A 64mm



Contenuto del set di seghe a tazza da 11 pezzi:
 seghe a tazza da 8 pezzi: 3/4" (19 mm), 7/8" (22 mm), 1-1/8" (29 mm), 1-1/4" (32 mm), 1-1/2" (38 mm), 1-3/4" (44 mm), 2" (51 mm), 2-1/2" (64 mm)
 2pz Alberino
 1pz Chiave esagonale: 2,5 mm

4-6TPI

HSS-M3

Codice	Misura	Pz/Conf	Master
75865T		5	30

SET 8pz FRESE A TAZZA BI-METALLO 64-76-89-102-127mm



Contenuto del set di seghe a tazza da 8 pezzi:
 seghe a tazza da 5 pezzi: 2-1/2" (64mm), 3" (76mm), 3-1/2" (89mm), 4" (102mm), 5" (127mm)
 1pz Alberino
 1pz Chiave a brugola: 2,5mm
 1pz Piastra driver

4-6TPI

HSS-M3

Codice	Misura	Pz/Conf	Master
75866T		5	20

VALIGETTA 9PZ FRESE A TAZZA BI-METALLO

Set di seghe a tazza bimetalliche Contenuto di 9 pezzi:
 Seghe a tazza 6 pezzi: 19 mm, 22 mm, 29 mm, 38 mm, 44mm, 57mm
 2pz Alberino: 9,5mm con gambo esagonale con punta
 HSS 14 -30 mm sega a tazza 11mm gambo esagonale con trapano
 HSS per sega a tazza 32-210mm
 1pz adattatore



4-6TPI

HSS-M3

Codice	Misura	Pz/Conf	Master
75861T		1	10

SET 12 PZ FRESE PER LEGNO GAMBO 6MM



pezzi per la pulizia del fondo: 8, 16 mm 1 pezzo per nucleo:
R6 mm 1 pezzo per scanalatura a V a 60 gradi: 15 mm 1 pezzo per coda di rondine: 16 mm 1 pezzo per punta a filo: 19 mm 1 pezzo per punta a 45 gradi: 27 mm 2 pezzi rotondi punta:
R6,
R10mm 2 pezzi punta conica:
R6,
R10mm 1 pezzo punta ogee romana:
R6.5mm
GAMBO: 1/4"

Codice	Misura	Pz/Conf	Master
75680T		1	20

ALBERINO PER FRESE A TAZZA 3/8" 14-30mm



Albero per sega a tazza
Dimensioni gambo: 3/8"
M2 HSS
Punta elicoidale con punta di spaccatura 135° 1/4" x 75 mm
Sega a tazza adatta: 14 mm-30 mm



Codice	Misura	Pz/Conf	Master
75700T	3/8" - 14-30mm	5	50

SET 15 PZ FRESE PER LEGNO GAMBO 8MM



Contiene:
Punte dritte: 3, 6, 12, 16 mm
Punta di rifinitura a filo: 1/2"
Punta a coda di rondine: 1/2"
Punta a mortasa: 1/2" 45°
Punta smussata: 32 mm
Punta a incavo: 1/2", 1/4"
Punta tonda angolare: 22,2, 28,6 mm
Punta ogee romana: 25,4 mm
Punta scanalata a V: 1/2"
Punta conica: 22,2 mm
Gambo: 8 mm



Codice	Misura	Pz/Conf	Master
75681T		1	20

ALBERINO PER FRESE A TAZZA 7/16" 32-152mm



Albero per sega a tazza
Dimensioni gambo: 7/16"
M2 Punta elicoidale
HSS con punta di spaccatura 135° 1/4" x 75 mm
Sega a tazza adatta: 32 mm-152 mm



Codice	Misura	Pz/Conf	Master
75701T	7/16" - 32-152mm	5	50

FRESE A TAZZA 26/63 SET 7pz ALTEZZA 50mm



Set di seghe a tazza da 7 pezzi
Diametro sega a tazza:
26,32,38,45,50,56,63 mm
Altezza: 50 mm (2")

Codice	Misura	Pz/Conf	Master
75870T	50mm	10	60

ALBERINO PER FRESE A TAZZA ATTACCO SDS-PLUS 3/8" 14-30mm



Albero per sega a tazza
Attacco SDS-PLUS
M2 Punta elicoidale
HSS con punta di spacco 135° 1/4" x 75 mm
Sega a tazza adatta: 14 mm-30 mm



Codice	Misura	Pz/Conf	Master
75702T	7/16" - 32-152m	5	50

FRESE A TAZZA 26/63 SET 7pz ALTEZZA 25mm



Set di seghe a tazza da 7 pezzi
Diametro sega a tazza: 26, 32, 38, 45, 50, 56, 63 mm
Altezza: 25 mm (1")

Codice	Misura	Pz/Conf	Master
75869T	25mm	10	60

ALBERINO PER FRESE A TAZZA ATTACCO SDS-PLUS 7/16" 32-152mm



Albero per sega a tazza
Attacco SDS-PLUS
M2 Punta elicoidale
HSS con punta di spacco 135° 1/4" x 75 mm
Sega a tazza adatta: 32 mm-152 mm



Codice	Misura	Pz/Conf	Master
75703T	7/16" - 32-152m	5	50

FRESE TCT DIAMANTATE



14 mm
Le frese a 3 strati riducono la rottura della punta anche con un uso intenso. La speciale punta in metallo duro può perforare la lamiera di acciaio inossidabile in modo uniforme e piacevole. Lunga durata dell'acciaio temprato. Applicare su trapani portatili e a colonna.



Codice	Misura	Pz/Conf	Master
75914T	14mm	1	80
75915T	15mm	1	80
75916T	16mm	1	80
75920T	20mm	1	80
75922T	22mm	1	80
75923T	23mm	1	80
75925T	25mm	1	80
75926T	26mm	1	80
75928T	28mm	1	80
75930T	30mm	1	60
75932T	32mm	1	60
75935T	35mm	1	60
75938T	38mm	1	60
75940T	40mm	1	60
75942T	42mm	1	40
75945T	45mm	1	40
75948T	48mm	1	40
75950T	50mm	1	40
75955T	55mm	1	40
75960T	60mm	1	40

FRESE TCT DIAMANTATE



14 mm
Le frese a 3 strati riducono la rottura della punta anche con un uso intenso. La speciale punta in metallo duro può perforare la lamiera di acciaio inossidabile in modo uniforme e piacevole. Lunga durata dell'acciaio temprato. Applicare su trapani portatili e a colonna.



Codice	Misura	Pz/Conf	Master
75965T	65mm	1	30
75970T	70mm	1	30
75975T	75mm	1	30

DISCHI DA TAGLIO METALLO



disco da taglio per metallo e acciaio inossidabile
Centro piatto



80 M/S

EN 12413



Codice	Misura	Pz/Conf	Master
76132T	115x1.0x22.2mm	50	400
76134T	115x1.6x22.2mm	50	400
76142T	115x3.0mm	25	200
76107T	230x2.0mm	25	100
76147T	230x3.0mm	25	50

DISCHI PER RETTIFICA METALLO



80 M/S

EN 12413



Codice	Misura	Pz/Conf	Master
76302T	115X6.0mm	10	100
76307T	230X6X222mm	5	30

DISCHI PER SEGHE CIRCOLARI TAGLIO LEGNO



Anello di riduzione: 16mm
Adatto per il taglio del legno

Codice	Misura	Pz/Conf	Master
76420T	110X40TX22.2	5	100
76450T	235X40TX30	1	25
76451T	235X60TX30	1	25
76470T	305X60TX30	5	10
76430T	185X24TX30mm	10	50
76431T	185x40Tx30mm	10	50
76432T	185x60Tx30mm	10	50
76460T	254x40Tx30mm	5	25
76461T	254x60Tx30mm	5	25
76425T	160x24Tx20mm	10	50
76426T	160x40Tx20mm	10	50

DISCHI PER SEGHE CIRCOLARI TAGLIO ALLUMINIO



Anello di riduzione:16/20/22.2/25.4mm
Adatto per il taglio dell'alluminio

Codice	Misura	Pz/Conf	Master
76540T	215X60TX30	5	50
76560T	254X80TX30	1	25
76570T	305X80TX30	1	10

DISCO DIAMANTATO CORONA SEGMENTATA



Larghezza lama: 10 mm

INDUSTRIAL J



Codice	Misura	Pz/Conf	Master
76702T	115x22.2	5	100
76703T	125x22.2mm	5	100
76707T	230x22.2	1	20

DISCO DIAMANTATO CORONA CONTINUA



Larghezza lama: 7 mm

INDUSTRIAL J



Codice	Misura	Pz/Conf	Master
76722T	115x22.2	5	100
76723T	125x22.2mm	5	100
76727T	230X22.2(20)mm	1	20

DISCO DIAMANTATO CORONA TURBO



Larghezza lama: 10 mm

INDUSTRIAL J



Codice	Misura	Pz/Conf	Master
76742T	115X22.2mm	5	100
76743T	125x22.2mm	5	100
76747T	230x22.2(20)mm	1	20

SET 5PZ LAME SEGHETTO PER LEGNO



T111C
Attacco a T
Materiale: HCS
Lunghezza totale: 100mm 8TPI
Taglio rapido per truciolare, compensato, pannelli di fibra, plastica sandwich

x5

Codice	Misura	Pz/Conf	Master
76801T	100mm	20	200

SET 5 LAME PER SEGHETTO ALTERNATIVO T244D



Materiale: HCS
Lunghezza totale: 100 mm
6TPI
Taglio curvo rapido per legno, pannelli truciolari, compensato, pannelli in fibra, plastica.

x5

Codice	Misura	Pz/Conf	Master
76803T	100mm	20	200

SET 5PZ LAME SEGHETTO PER LEGNO TAGLIO DI PRECISIONE



T101B
Attacco a T
Materiale: HCS
Lunghezza totale: 100 mm 10TPI
Taglio rapido e preciso per legno, truciolari, compensato, pannelli di fibra, plastica.

x5

Codice	Misura	Pz/Conf	Master
76804T	100mm	20	200

SET 5PZ LAME SEGHETTO PER FERRO



T118A
Attacco a T
Materiale: HSS
Lunghezza totale: 75 mm 21TPI
Taglio dritto per metallo sottile metallo non ferroso e alluminio sandwich

x5

Codice	Misura	Pz/Conf	Master
76811T	75mm	20	200

SET 10 PZ LAME RICAMBIO MISTE PER SEGA A GATTOCCIO



4 pezzi 150 x 19 x 1,27mm 6TPI, materiale: 65 Mn per il taglio del legno
2 pezzi 150 x 19 x 1,27mm 10TPI, Materiale: 65 Mn per il taglio del legno
2 pezzi 150 x 19 x 0,92mm 18TPI, materiale: HSS M2 per il taglio dei metalli
2 pezzi 200 x 19 x 1,27mm 6TPI, Materiale: 65 Mn per il taglio del legno
Confezione: blister

Codice	Misura	Pz/Conf	Master
76830T		6	48

PUNTA CONICA HSS 4-32 X 2MM



HSS, temprato 4-32*2 mm
Superficie del rivestimento in titanio

Codice	Misura	Pz/Conf	Master
75873T	4-32*2mm	1	40

SET 3PZ PUNTE CONICHE HSS



HSS, temprato
Contiene: 4-12 * 2 mm 4-20 * 2 mm 4-32 * 2 mm
Superficie del rivestimento in titanio

Codice	Misura	Pz/Conf	Master
75878T		1	20

SET FORATURA 4 PZ CON TELAIO DI POSIZIONAMENTO



2 seghe a tazza: 25mm, 54mm
Profondità di taglio della sega a tazza: 50 mm
Dimensioni della punta: 6x76 mm
Telaio in plastica di posizionamento in ABS
Spessore regolabile della porta da 35-45 mm
Regolabile in profondità da 60 a 70 mm
Confezione: blister

Codice	Misura	Pz/Conf	Master
75863T	25-54mm	5	20

FOGLI ABRASIVI VELCRATI PER LEVIGATRICE ROTORBITALE 79565T



Adatto per
TOLSEN 79565 / 79761
Ideale per metallo, legno e vernice
Supporto in fibra di alta qualità per
più tempi di utilizzo



Codice	Misura	Pz/Conf	Master
77231T	gr.40	10	200
77232T	gr. 60	10	200
77233T	gr.80	10	200
77234T	gr. 120	10	200
77235T	gr.150	10	200
77236T	gr.180	10	200
77237T	gr. 240	10	200

FOGLI ABRASIVI VELCRATI PER LEVIGATRICE TRIANGOLARE 79561T



Adatto per
TOLSEN 79561
Ideale per metallo, legno e vernice
Supporto in fibra di alta qualità per
più tempi di utilizzo



Codice	Misura	Pz/Conf	Master
77241T	gr.40	10	100
77242T	gr.60	10	100
77243T	gr.80	10	100
77244T	gr.120	10	100
77245T	gr.150	10	100
77246T	gr.180	10	100
77247T	gr.240	10	100

PLATORELLI CON VELCRO



Diametro: 115 mm
Materiale:
PP +
EVA

Codice	Misura	Pz/Conf	Master
77260T	115mm	5	100
77261T	125mm	5	100
77262T	150mm	5	60

DISCHI LAMELLARI



Approvato
MPA 115x22.2mm 40#
Per acciaio e legno

T29
SUPERFICE CONICA
PER UNA MAGGIORE
PERFORMANCE LEVIGANTE



Codice	Misura	Pz/Conf	Master
77211T	115 x 40gr	20	160
77212T	116 x 60gr	20	160
77213T	117 x 80gr	20	160
77215T	118 x 120gr	20	160

SET 5pz MOLE ABRASIVE



Ø6*27mm 23000
RPM 3 pezzi di ossido di alluminio
marrone 1 pezzo di ossido di alluminio
rosa 1 pezzo di ossido di alluminio
bianco

Codice	Misura	Pz/Conf	Master
77110T		6	100

SPAZZOLA CIRCOLARE CONICA 100mm



Diametro filo: 0,3 mm
Filettatura: M14 * 2



INDUSTRIAL



Codice	Misura	Pz/Conf	Master
77627T	100mm	6	60

SPAZZOLA CIRCOLARE 125mm

diametro filo: 0,3 mm
Dimensioni albero: 22,2 mm
Con anello da 16 mm e 13 mm



INDUSTRIAL



Codice	Misura	Pz/Conf	Master
77527T	125mm	6	60

SPAZZOLA CIRCOLARE CONICA CON FILI RITORTI 100mm EX 77520T



Diametro filo: 0,5 mm
Filettatura: M14 * 2



Codice	Misura	Pz/Conf	Master
77629T	100mm	6	48

SPAZZOLA FRONTALE CON GAMBO



Diametro gambo: 6,35 mm
Imballaggio: blister



INDUSTRIAL

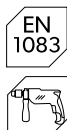

Codice	Misura	Pz/Conf	Master
77546T	24mm	20	120

SPAZZOLE CIRCOLARI FILI RITORTI



diametro filo: 0,5 mm
Dimensioni albero: 22,2 mm



INDUSTRIAL

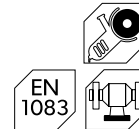

Codice	Misura	Pz/Conf	Master
77533T	125mm	6	60
77534T	150mm	5	40
77535T	180mm	6	24

SPAZZOLE CIRCOLARI CON GAMBO



diametro filo: 0,3 mm
Diametro gambo: 6,35 mm
Imballaggio: blister



INDUSTRIAL

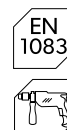

Codice	Misura	Pz/Conf	Master
77540T	50mm	20	80
77542T	75mm	20	80
77543T	100mm	12	72

SPAZZOLE A TAZZA CON GAMBO



Diametro gambo: 6,35 mm
Imballaggio: blister



INDUSTRIAL

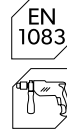

Codice	Misura	Pz/Conf	Master
77548T	50mm	20	80
77550T	75mm	20	80

SET 5PZ SPAZZOLE PER TRAPANO MISTE



Spazzole con estremità in filo da 1" con gambo
 Spazzola a filo circolare da 2"-3" con gambo
 Spazzola a tazza da 2"-3" con diametro del filo del gambo: 0,3 mm
 Diametro gambo: 6,35 mm (1/4") Imballaggio: blister

INDUSTRIAL

EN 1083



Codice	Misura	Pz/Conf	Master
77552T		6	24

SPAZZOLE A TAZZA



Diametro filo: 0,3mm
 Filettatura: M14 * 2

INDUSTRIAL

EN 1083



Codice	Misura	Pz/Conf	Master
77603T	M14x125mm	6	24
77601T	M14x75mm	6	48
77602T	M14x100mm	6	36

SET 5PZ SPAZZOLE ATTACCO DA 1/4"



Spazzole con estremità in filo da 1" con gambo
 Spazzola a filo circolare da 2"-3" con gambo
 Spazzola a tazza da 2"-3" con diametro del filo del gambo: 0,3 mm
 Diametro gambo: 6,35 mm (1/4") Imballaggio: blister

INDUSTRIAL

EN 1083



Codice	Misura	Pz/Conf	Master
77553T	1/4"	6	24

SPAZZOLE A TAZZA FILI RITORTI



Diametro filo: 0,5mm
 Filettatura: M14 * 2

INDUSTRIAL

EN 1083



Codice	Misura	Pz/Conf	Master
77611T	M14x75mm	8	48
77612T	M14x100mm	6	36
77510T	M14x125mm	6	24

SET 250PZ ACCESSORI PER MINI SMERIGLIATRICE

- Adatto per TOLSEN 79555 76 pz Disco da taglio
- 60 pz carta abrasiva
- 1 pz mola in gomma
- 10 pz Mola con gambo
- 4 pz per lucidatura in gomma 5 pz feltro
- 1 pz Punta i
- 1 pz stoffa 1 pz
- 39 pz accessori abrasivi Pennello da 6 pezzi
- 7 pezzi di punte diamantate Punta per incisione 2 pezzi 4 punte per mandrino
- 2 pezzi per levigatura
- 6 punte da trapano Hss
- 4 pezzi Collettori
- 1 pz Ruota lamellare
- 1 chiave inglese
- 1 pezzo di pietra

Codice	Misura	Pz/Conf	Master
77115T		6	6



BATTERIA 12V 1.5AH PER AVVITATORI 79023T E 79025T



Voltaggio: DC 12V
Alimentazione: Li-ion, 1x1500mAh
Adatto per TOLSEN 79023/79025

Codice	Misura	Pz/Conf	Master
79029T		1	20

BATTERIA PER AVVITATORE 12V 79036T E 79037T



Voltaggio: AC 12V
Alimentazione: Li-ion, 1x1500mAh
Adatto per TOLSEN 79036/79037

Codice	Misura	Pz/Conf	Master
79039T		1	20

CHIAVI PER MANDRINO



Chiave per mandrino da 10 mm
Lunghezza: 110 mm



Codice	Misura	Pz/Conf	Master
79180T	10mm	20	100
79181T	13mm	20	100

MANDRINI CON CHIAVE



Dimensioni connessione: 3/8 "-24UNF



Codice	Misura	Pz/Conf	Master
79160T	10mm	5	50
79161T	13mm	5	40

ADATTATORE SDS



Codice	Misura	Pz/Conf	Master
79176T		10	400

FRUSTA RICAMBIO 140X600MM PER AGITATORE VERNICI 79509T

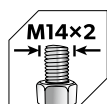

Codice	Misura	Pz/Conf	Master
79509-57	140 x 600mm	6	12

MANDRINI AUTOSERRANTI



Dimensioni della connessione: 3/8 "-24UNF



Codice	Misura	Pz/Conf	Master
79170T	10mm	5	50
79171T	13mm	5	40



TOLSEN

ZZZZZZ
WWW
NNN
JJJ
OOO

MARTELLI TEDESCHI MANICO FIBRA



Testa martello forgiata in acciaio speciale per utensili, verniciata nera, trattamento termico, impugnatura in fibra di vetro

GRIPPro
series

Codice	Misura	Pz/Conf	Master
25000T	100gr	6	60
25001T	200gr	6	60
25002T	300gr	6	36
25003T	500gr	6	24
25006T	1,0kg	4	16
25007T	1,5kg	4	8
25008T	2,0kg	4	8

MARTELLI TEDESCHI MANICO LEGNO



Testa martello forgiata in acciaio speciale per utensili, verniciata nera, trattamento termico, impugnatura in legno

Codice	Misura	Pz/Conf	Master
25129T	100gr	6	60
25121T	200gr	6	60
25122T	300gr	6	48
25123T	500gr	6	24
25124T	1kg	4	16
25125T	1,5kg	4	8
25126T	2,0kg	4	8

MARTELLI TIRACHIODI MANICO FIBRA



Testa martello in acciaio speciale per utensili forgiato a goccia, trattamento termico, impugnatura in fibra di vetro rettificata e lucidata 23mm

GRIPPro
series

Codice	Misura	Pz/Conf	Master
25028T	225gr	6	36
25030T	450gr	6	24
25031T	560gr	6	24

MARTELLI TIRACHIODI MANICO LEGNO



Testa martello in acciaio speciale per utensili forgiato a goccia, trattamento termico, molato
Manico in legno lucidato 23 mm

Codice	Misura	Pz/Conf	Master
25148T	225gr	6	36
25150T	450gr	6	24
25032T	560gr	6	24

MARTELLO CON TESTA TONDA E PENNA SFERICA MANICO FIBRA



GRIPPro
series

Codice	Misura	Pz/Conf	Master
25022T	450gr	6	24

MARTELLO CON TESTA TONDA E PENNA SFERICA MANICO LEGNO



Codice	Misura	Pz/Conf	Master
25142T	450gr	6	24

MARTELLI FORGIATO IN ACCIAIO 600gr

Solido pezzo unico forgiato, temprato e rinvenuto;
Completamente lucidato e laccato;
Solido albero forgiato con impugnatura in fibra di vetro che assorbe il calcio per ridurre le vibrazioni durante i colpi;
Con portachiodi magnetico;

PREMIUM

GRIPPro series



Codice	Misura	Pz/Conf	Master
25171T	600gr	4	16

MARTELLI DA CARPENTIERE 600gr

Testa martello in acciaio speciale per utensili forgiato a goccia
Trattamento termico

INDUSTRIAL

GRIPPro series



INCAVO MAGNETICO

Codice	Misura	Pz/Conf	Master
25167T	600gr	4	16

MAZZETTE MANICO FIBRA

Testa martello forgiata in acciaio speciale per utensili, verniciata nera, trattamento termico, impugnatura fibra di vetro 1000g

GRIPPro series



Codice	Misura	Pz/Conf	Master
25010T	1,0kg	4	16
25012T	1,5kg	4	12
25013T	2,0kg	4	8

MAZZETTE MANICO LEGNO

Testa martello forgiata in acciaio speciale per utensili, verniciata nera, trattamento termico, impugnatura in legno 1000 g



Codice	Misura	Pz/Conf	Master
25130T	1kg	4	16
25132T	1,5kg	4	12
25133T	2,0kg	4	8

MARTELLI TESTA IN GOMMA

Manico in fibra di vetro a testa di martello in gomma 220 g

GRIPPro series



Codice	Misura	Pz/Conf	Master
25033T	225gr	6	36
25035T	450gr	6	24
25037T	675gr	6	24
25038T	900gr	6	12

MARTELLI IN GOMMA NATURALE

Dimensioni: 450 g
Gomma naturale, tipo morbido
Manico in fibra di vetro

NEW

GRIPPro series



Codice	Misura	Pz/Conf	Master
25175T	450gr	4	24
25177T	675gr	4	16

ASCIA MANICO FIBRA



Acciaio speciale forgiato per utensili verniciato nero, trattamento termico, impugnatura in vetroresina 600 g

GRIPPro series

ASCE MANICO LEGNO



Acciaio speciale per utensili forgiato a goccia
Testa rettificata e lucidata
Manico in legno 600g

Codice	Misura	Pz/Conf	Master
25053T	600gr.	6	24
25054T	800gr	1	8

Codice	Misura	Pz/Conf	Master
25253T	600gr	6	24
25254T	800gr	6	24
25255T	1000gr	4	12
25256T	1250gr	4	12

MAZZE TESTA A GOCCIA

Testa martello in acciaio speciale per utensili forgiato a goccia, verniciato nero, trattamento termico, impugnatura in fibra di vetro lunga 680 mm; 2,7 kg



GRIPPro series

ASCIA MANICO FIBRA 1250GR

Acciaio speciale forgiato per utensili verniciato nero, trattamento termico, impugnatura in fibra di vetro bicomponente
Lunghezza 800mm



GRIPPro series

Codice	Misura	Pz/Conf	Master
25045T	2,7kg	1	6
25046T	3,6kg	1	4
25047T	4,5kg	1	4

Codice	Misura	Pz/Conf	Master
25051T	1250 gr.	1	12

MAZZA MANICO FIBRA 5KG

Testa martello forgiata in acciaio speciale per utensili, verniciata nera, trattamento termico, impugnatura in fibra di vetro 900 mm di lunghezza; 5 kg



GRIPPro series

MARTELLINO TESTA IN GOMMA/NYLON 35MM

Testa in PVC
Manico in fibra di vetro 35 mm



GRIPPro series

Codice	Misura	Pz/Conf	Master
25016T	5 KG.	1	4

Codice	Misura	Pz/Conf	Master
25042T	35mm	6	36

SCALPELLI PER LEGNO



CrV
Manico in plastica bicomponente



GRIPPro
series

INDUSTRIAL

Codice	Misura	Pz/Conf	Master
25056T	6mm	5	60
25060T	10mm	5	60
25062T	13mm	5	60
25065T	16mm	5	60
25067T	19mm	5	60
25069T	22mm	5	60
25071T	25mm	5	60
25073T	32mm	5	40
25075T	38mm	5	40
25079T	51mm	5	40
25058T	8mm	5	60
25061T	12mm	5	60

MARTELLINO IN PVC



NEW

Martello a colpo secco utile per ridurre al minimo i danni sulla superficie colpita e controllare la forza di colpo
Dimensioni : 900gr
Testa in plastica PVC antiscivolo
Non rimbalzante
Antiscintilla

Codice	Misura	Pz/Conf	Master
25040T	900 gr.	4	16

SET 4PZ SCALPELLI PER LEGNO



GRIPPro
series

INDUSTRIAL

Codice	Misura	Pz/Conf	Master
25384T	6-13-19-25mm	6	12

SCALPELLI A PUNTA CON IMPUGNATURA



4 * 16 * 250 mm
Acciaio speciale per utensili;
HRC52-57;
Verniciato a polvere



Codice	Misura	Pz/Conf	Master
25082T	4x16x250mm	6	36
25085T	4x18x300mm	6	24

SCALPELLI PIATTI CON IMPUGNATURA



Acciaio speciale per utensili;
HRC52-57;
Verniciato a polvere



Codice	Misura	Pz/Conf	Master
25087T	22x16x250mm	6	36
25088T	24x18x300mm	6	36

TOLSEN

UTENSILI DA TAGLIO



CUTTER DA 18mm IN PLASTICA



Corpo in ABS
 Dimensioni lama: 18 * 100 mm
 Con pulsante piatto
 Confezione: sacchetto OPP

Codice	Misura	Pz/Conf	Master
30081T	18mm	24	240

CUTTER DA 9mm IN PLASTICA



Custodia in ABS
 Dimensioni lama: 9 * 80 MM
 Con pulsante piatto
 Confezione: sacchetto OPP

Codice	Misura	Pz/Conf	Master
30004T	9mm	100	800

CUTTER DA 18mm DISPLAY



Custodia in ABS
 Dimensioni lama: 18 * 100 mm
 Con pulsante piatto
 Confezione: display 24pz

Codice	Misura	Pz/Conf	Master
30001T	18mm	24	96

CUTTER DA 9mm IN METALLO DISPLAY 48PZ



Cassa in acciaio
 Dimensioni lama: 9 * 80mm
 Con pulsante piatto



Codice	Misura	Pz/Conf	Master
30005T	9mm	48	960

CUTTER DA 18mm IN METALLO



Custodia in alluminio
 Dimensioni lama: 18 * 100 MM
 Con pulsante piatto



Codice	Misura	Pz/Conf	Master
30002T	18mm	12	144

CUTTER PROFESSIONALE PIEGHEVOLE



Manico in alluminio 61x19mm
 Con 5 lame SK5

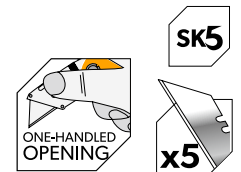

Codice	Misura	Pz/Conf	Master
30007T	61x19mm	12	72

CUTTER PROFESSIONALE EX 30009T



Corpo in lega di zinco
 TPR
 Materiale della lama: SK2
 Funzione di blocco automatico
 Funzione retrattile automatica
 Lama a cambio rapido
 Compresa 2 lame SK2 aggiuntive



Codice	Misura	Pz/Conf	Master
30019T		6	60

CUTTER IN ALLUMINIO CON LAMA DI SICUREZZA RETRATTILE



Corpo in lega di alluminio
 Materiale della lama:
 SK5 61 * 19MM

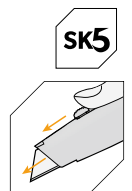

Codice	Misura	Pz/Conf	Master
30008T	61x19mm	12	96

LAME RICAMBIO CUTTER



Lame da 10 pezzi 18 * 100 * 0,5 mm



Codice	Misura	Pz/Conf	Master
30011T	18mm	20	240
30012T	9mm	40	480

LAME RICAMBIO CUTTER



Materiale:
SK5
Dimensioni lama: 25 * 125 * 0,7 mm



Codice	Misura	Pz/Conf	Master
30017T	25mm	10	80

SET 10 PZ LAME CUTTER TRAPEZOIDALI 61x19mm

Lame da 10 pezzi 61 * 19 * 0,6 mm,
SK5



Codice	Misura	Pz/Conf	Master
30010T	61x19mm	24	240

SET 10PZ LAME CUTTER AD UNCINO



Misure: 50x31x19mm
Spessore: 0,6mm
Materiale:
SK5, trattamento termico, fori di
posizionamento



Codice	Misura	Pz/Conf	Master
30113T	50x31x19mm	10	240

CUTTER DA 18mm CON TRE LAME EX 30015T

Custodia in
ABS + TPR
Lame autobloccanti 3 pezzi
SK2, 18x100MM



Codice	Misura	Pz/Conf	Master
30090T	18mm	24	96

CUTTER DA 25mm CON 3 LAME

Custodia in ABS + TPR
Dimensioni lama: 25 * 125 * 0,7 mm; SK5;
Lame autocaricanti
Con lame da 3 pezzi 25 * 125 * 0,7 MM
Con pulsante piatto



Codice	Misura	Pz/Conf	Master
30016T	25mm	6	48

RASCHIETTO PER VETRI IN ABS

174 * 70 * 22,5 mm
Custodia in
ABS
Lama
SK5
Dimensioni lama: 61 * 19 * 0,6 mm



Codice	Misura	Pz/Conf	Master
30014T	61x19mm	10	200

CUTTER CON LAMA RETRATTILE TRAPEZOIDALE

Corpo in ABS trasparente
Dimensioni complessive: 153x38,5x26
mm
Con 1 lama SK7: 61x19 mm
Le lame si ripongono saldamente nel
manico



Codice	Misura	Pz/Conf	Master
30086T	61x19mm	12	144

FORBICI PER LATTONERIA



10"
Acciaio speciale per utensili



Codice	Misura	Pz/Conf	Master
30036T	250mm	6	24
30037T	300mm	5	20

FORBICI USO DOMESTICO 200mm



Lama in acciaio inossidabile 8"



Codice	Misura	Pz/Conf	Master
30044T	200mm	12	144

FORBICI DA CUCINA 200mm



Lama in acciaio inossidabile 8"



Codice	Misura	Pz/Conf	Master
30045T	200mm	12	144

FORBICI MULTIUSO PROFESSIONALI 220mm



Multiuso: forbici, coltellino, schiaccianoci, tagliacavi, tronchese, levascaglie di pesce, apribottiglie, apribarattolo, pelapatate, cacciavite a taglio
Lama in acciaio inox
Grande impugnatura ergonomica antiscivolo



Codice	Misura	Pz/Conf	Master
30049T	220mm	6	72

COLTELLO MULTIFUNZIONE TASCABILE 15 IN 1



15
FUNCTIONS
STAINLESS
STEEL
BLADE



15 funzioni, manico in alluminio, acciaio inossidabile, coltello, apriscatole, cacciavite a stella, punzone, apribottiglia, forbici, ago, cacciavite, lima, sega, cavatappi, punzone, portachiavi.

Codice	Misura	Pz/Conf	Master
30048T		12	72

SEGHETTO PUCK 150mm



inclusa 1 lama



Codice	Misura	Pz/Conf	Master
30050T	150mm	20	120

SEGHETTO MINI 150mm



Manico rivestito in plastica
Inclusa 1 lama



Codice	Misura	Pz/Conf	Master
30051T	150mm	12	120

INDUSTRIAL

SET 10pz LAME SEGHETTO PUCK 150mm



150 mm / 6"
Materiale: SK4
Superficie rifinita nera 24 denti
Adatto per 30050 e 30051
Confezione da 10 pezzi



x10

Codice	Misura	Pz/Conf	Master
30060T	150mm	10	200

INDUSTRIAL

SEGA DA 300mm

Telaio ad arco in tubo d'acciaio laccato quadrato
Con impugnatura in ABS
Inclusa lama per sega da 1 pezzo



Codice	Misura	Pz/Conf	Master
30052T	300mm	6	60

SEGA PROFESSIONALE 300mm

300 mm/12 "Telaio ad arco in tubo d'acciaio laccato quadrato
Con impugnatura in alluminio e TPR
Inclusa lama per sega da 1 pezzo

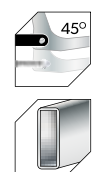

Codice	Misura	Pz/Conf	Master
30054T	300mm	6	36

LAME RICAMBIO BI-METALLO DA 300mm BOX 100PZ

300 x 12 mm
Materiale: M2+D6A
Numero di denti: 24T
100 pezzi confezionati in scatola di plastica



x100

Codice	Misura	Pz/Conf	Master
30065T	300mm	1	10

RASCHIETTO PER VETRI CON IMPUGNATURA

Testa di taglio in alluminio da 300 mm
Lama SK5: 100x18x0,5 mm
Tubo in acciaio con impugnatura morbida
Ideale per rimuovere la vernice secca da finestre di vetro,
raschiare carta da parati e altre applicazioni simili



SK5

Codice	Misura	Pz/Conf	Master
30101T	300mm	3	48
30102T	600mm	6	36

TAGLIACORNICI IN PLASTICA 300mm

Dimensioni della sega: 300 mm Lama 13TPI 65Mn
Spessore: 0,9 mm
Dimensioni della scatola della mitra: 300 * 140 * 70 mm
Materiale ABS



Codice	Misura	Pz/Conf	Master
31017T	300mm	6	12

RASCHIETTO PER FUGHE



Materiale: plastica di alta qualità e metallo duro, la lama "stile diamantato" ti aiuta a rimuovere la malta, testa angolata, impugnatura ergonomica.



Codice	Misura	Pz/Conf	Master
41047T		10	60

TOLSEN

NUOVI ORIZZONTI
PER I TUOI PROGETTI.



TOLSEN

UTENSILI PER ARIA COMPRESSA



TUBI A SPIRALE



Lunghezza : 10 m
 Diametro interno: 6 mm
 Diametro esterno: 8 mm
 Pressione massima di esercizio: 10 Bar (144 psi)
 Raccordo tubo: 1/4"



Codice	Misura	Pz/Conf	Master
73151T	6x8x10mt	5	25
73152T	6x8x15mt	5	25

PISTOLA A SPRUZZO A CADUTA



Omologazione CE
 Tipo di alimentazione: Gravità
 Ugello standard: 1,4 mm
 Consumo d'aria: 6 cfm
 Pressione dell'aria di esercizio: 3,5-5 bar
 Larghezza del modello: 160-260 mm
 Capacità della vernice: 600 ml

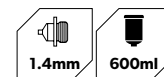

Codice	Misura	Pz/Conf	Master
73175T	600 ml	3	18

PISTOLA A SPRUZZO HVLP A CADUTA



Omologazione CE
 Tipo di alimentazione: Gravità
 Ugello standard: 0,8 mm
 Consumo d'aria: 6 cfm
 Pressione dell'aria di esercizio: 3,5 bar
 Larghezza del motivo: 160-250 mm
 Capacità della vernice: 100 ml

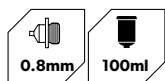

Codice	Misura	Pz/Conf	Master
73160T	100 ml	3	20

PISTOLA A SPRUZZO ASPIRAZIONE HVLP



Omologazione CE
 Tipo di alimentazione: Aspirazione
 Ugello standard: 1,4 mm
 Consumo d'aria: 6 cfm
 Pressione dell'aria di esercizio: 3,5 bar
 Larghezza del modello: 200-290 mm
 Capacità della vernice: 1000 ml

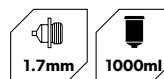

Codice	Misura	Pz/Conf	Master
73180T	1000 ml	1	10

PISTOLA A SPRUZZO HVLP A CADUTA



Omologazione CE
 Tipo di alimentazione: Gravità
 Ugello standard: 1,4 mm
 Consumo d'aria: 6 cfm
 Pressione dell'aria di esercizio: 3,5 bar
 Larghezza del modello: 180-280 mm
 Capacità della vernice: 600 ml

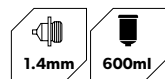

Codice	Misura	Pz/Conf	Master
73170T	600 ml	1	18

PISTOLA A SPRUZZO ASPIRAZIONE



Omologazione CE
 Tipo di alimentazione: Aspirazione
 Ugello standard: 1,7 mm
 Consumo d'aria: 7 cfm
 Pressione dell'aria di esercizio: 3,5-5 bar
 Larghezza del modello: 160-240 mm
 Capacità della vernice: 1000 ml

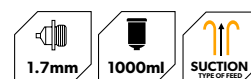

Codice	Misura	Pz/Conf	Master
73185T	1000 ml	1	10

PISTOLA A SPRUZZO PER LAVAGGIO CON SERBATOIO DA 1LT



Dimensioni ugello: 215 mm
Capacità di lavaggio: 1000 ml
Pressione di esercizio: 4 bar

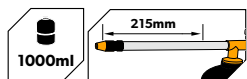

Codice	Misura	Pz/Conf	Master
73191T	1lt	3	10

KIT 5pz PER ARIA COMPRESSA

Pistola ad aria compressa: 600 ml,
Pistola ad aria compressa: lunghezza ugello 20 mm,
Pistola lavaggio aria: 1000 ml,
Pistola ad aria compressa: 0-12 bar e 0-170 psi;
Raccordi filettati da 1/4"
Tubo dell'aria a spirale



Codice	Misura	Pz/Conf	Master
73198T		1	8

PISTOLA PER ARIA COMPRESSA CON MANOMETRO



Impugnatura a pistola con quadrante
Il quadrante legge 0-12 bar e 0-170 psi
Adatto per l'uso con veicoli a motore, biciclette, gommoni, ecc.
Connettore a clip
Connettori filettati da 1/4"
Lunghezza: 40 cm

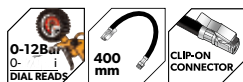

Codice	Misura	Pz/Conf	Master
73193T		6	36

PISTOLA PER SOFFIAGGIO



Omologazione CE
Adatto per la pulizia di liquidi, trucioli o polvere durante la produzione o il montaggio
Lunghezza ugello 20 mm



Codice	Misura	Pz/Conf	Master
73195T		5	40

CHIODATRICE PNEUMATICA

Omologazione CE
Adatto per:

chiodi formato F 18Ga. 1,26*1,05 mm: 10-50 mm (5/8" - 2")
graffette formato K 18Ga. 1,26*1,05 mm: 13-40 mm (5/8" - 1-5/8")
Capacità caricatore: 100 pz

Pressione di esercizio: 70psi(0.5Mpa)-110psi(0.75Mpa) Ingresso aria: 1/4"

Peso netto: 1,3 kg

Caratteristiche

Scarico orientabile a 360°

Profondità regolabile

La punta protegge la superficie di lavoro

Indicatore di ricarica

Accessori

chiodi formato F 300 pezzi

graffette formato K 300 pezzi

2 chiavi esagonali

1 bottiglia lubrificante

Attacco rapido 3 pezzi con filettatura maschio PT da 1/4".



NEW



18Ga
100 pcs
MAGAZINE CAPACITY
70psi
0.5Mpa
110psi
0.75Mpa

FBRADS	2mm (0.079")
15mm	5/8"
20mm	3/4"
25mm	1"
30mm	1-3/16"
32mm	3/8"
35mm	1-3/8"
38mm	1-1/2"
40mm	1-5/8"
45mm	1-3/4"
50mm	2"

18Ga
1.26x1.05mm
(0.050"x0.041")

K STAPLES	5.7mm (1/4")
16mm	5/8"
19mm	3/4"
25mm	1"
32mm	1-1/4"
38mm	1-1/2"
40mm	1-5/8"

18Ga
1.26x1.05mm
(0.050"x0.041")

Codice	Misura	Pz/Conf	Master
73420T		1	6

EXPERT



TOOLS

TOLSEN

UTENSILI PER EDILIZIA



LEVERINI DA CARPENTIERE

Acciaio al carbonio forgiato con trattamento termico
HRC 52-56; verniciato a polvere



Codice	Misura	Pz/Conf	Master
25109T	600x16mm	1	12
25111T	750x18mm	1	12

LEVERINI DA CARPENTIERE TIPO PESANTE

Acciaio al carbonio forgiato con trattamento termico
HRC 52-56; verniciato a polvere



Codice	Misura	Pz/Conf	Master
25118T	610mm	1	6
25119T	910 mm	1	6
25120T	1200mm	1	4

LEVERINI DA CARPENTIERE PIATTI



Codice	Misura	Pz/Conf	Master
25113T	180mm	20	100
25115T	375x35x6mm	10	20

FORBICI PER TAGLIO LAMIERA

Acciaio Cr-Mo
Lunghezza: 250MM
Manico in plastica bicomponente



GRIPPro series



INDUSTRIAL

Codice	Misura	Pz/Conf	Master
30021T	SINISTRO	5	30
30022T	DRITTO	5	30
30023T	DESTRO	5	30

FORBICI PER LAMIERA LAMA LUNGA

Dimensioni: 300 mm
Lunghezza di taglio: 80 mm Lama forgiate in cromo molibdeno per maggiore resistenza e durata Manico in plastica bicomponente Capacità di taglio di lamiera di acciaio laminato a freddo fino a 1,0 mm, alluminio da 1,5 mm, acciaio inossidabile da 0,7 mm.



NEW GRIPPro series



INDUSTRIAL

Codice	Misura	Pz/Conf	Master
30024T	300m Lama 8cm	5	30

FORBICI PER LAMIERA PROFESSIONALI

Dimensioni: 250 mm
Lunghezza di taglio: 40 mm Capacità di taglio: acciaio inossidabile da 1,0 mm; lamiera di ferro da 1,2 mm
Adatte per reti di acciaio
La lama della cesoia è fissata tramite bullone autobloccante in nylon anteriore e posteriore, in modo che sia più solida e abbia una durata di utilizzo più lunga.



NEW GRIPPro series



INDUSTRIAL

Codice	Misura	Pz/Conf	Master
30028T	250mm Lama 4cm	6	24

SPATOLE SENZA MANICO SET 4pz



50-80-100-120mm
Acciaio per utensili di alta qualità
Manico in plastica finemente lucidato

Codice	Misura	Pz/Conf	Master
40008T	50-80-100-120mm	5	120

SPATOLA MULTIFUNZIONE 6 IN 1



Raschietto, Rimuovi stucco, Spargitore, Ritaglio semicircolare per rimuovere la vernice dal rullo, Punta acuminata per aprire crepe da rattoppi, Foro centrale per sollevare i chiodi. Lama in acciaio inossidabile completamente temprato Lucidato a specchio Manico in plastica bicomponente

INDUSTRIAL

Codice	Misura	Pz/Conf	Master
40010T	6,35cm	12	72

FORETTO PER CARTONGESSO 150mm



lama 150MM 7TPI 65Mn
Con manico in plastica bicomponente

Codice	Misura	Pz/Conf	Master
31013T	150mm	6	48

SEGA PER SIPOREX 550mm 13 TPI

22" / 550mm
Lama 13TPI 65Mn, trattata termicamente
Con denti con punta in carburo
Manico in plastica bicomponente
Ideale per cemento cellulare, mattoni, blocchi di ghiaccio, ecc.



Codice	Misura	Pz/Conf	Master
31065T	550mm	6	18

SPATOLE



Acciaio per utensili di alta qualità,
trattato termicamente
Lucidato a specchio

Impugnatura bicomponente

Codice	Misura	Pz/Conf	Master
40012T	40mm	12	120
40014T	60mm	12	120
40015T	80mm	12	120
40016T	100mm	12	120
40017T	120mm	12	120

VASCHETTA PER RULLI

365 * 275 * 60 mm
Materiale plastico



Codice	Misura	Pz/Conf	Master
40096T	360x285mm	10	50

ASTE PER RULLI TELESCOPICHE

Verniciato a polvere
Adatto per codice
TOLSEN: 40054; 40057;
40059; Prolunga collegata con
40112, compatibile con codice
TOLSEN: 40075; 40077;
40079; 40090; 40091;



Codice	Misura	Pz/Conf	Master
40110T	1mt - 2mt	6	24
40111T	1,5mt - 3mt	6	24

FRUSTE PER AGITATORI



Acciaio speciale per utensili con verniciatura a polvere
Foro per appenderlo in gomma



Codice	Misura	Pz/Conf	Master
40098T	400X80mm	5	60
40099T	600X100mm	5	30

FRUSTE PER AGITATORI ATTACCO SDS-PLUS



400X80X8mm
Acciaio speciale per utensili con verniciatura a polvere
Foro per appenderlo in gomma



Codice	Misura	Pz/Conf	Master
40101T	SDS 400x80mm	5	60
40102T	SDS 600x100mm	5	20

FRUSTA RICAMBIO 140X600MM PER AGITATORE VERNICI 79509T

Dimensioni: 140x600 mm
Acciaio per utensili di alta qualità Superficie zincata
Filettatura del miscelatore: M14

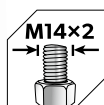

Codice	Misura	Pz/Conf	Master
40104T	140 x 600mm	6	12

FRATTONE SPUGNA 240x100

4" * 9-1/2" * 3/4" (240 * 100 * 19 mm)
Materiale: gomma
Imballaggio: borsa con adesivo colorato



Codice	Misura	Pz/Conf	Master
41022T	240x100mm	12	48

FRATTONE AMERICANO LISCIO



Cazzuola per intonacatura (manico in plastica)
Acciaio inossidabile 280x120mm
Manico in plastica bicomponente



Codice	Misura	Pz/Conf	Master
41016T	280x120mm	12	48

FRATTONE AMERICANO DENTATO



Cazzuola per intonacatura con denti (manico in legno)
Acciaio inossidabile 280x120mm
Denti: 10*10mm
Manico in plastica bicomponente



Codice	Misura	Pz/Conf	Master
41017T	280x120mm	12	48

FRATTONE PER BOIACCA

Manico in plastica TPR
BASE 250x95x13MM



Codice	Misura	Pz/Conf	Master
41018T	250x95x13mm	6	48

FRATTONE PER MALTA

230 * 100 * 10 mm
Materiale: EVA
Imballaggio: poli sacchetto



Codice	Misura	Pz/Conf	Master
41019T	230x100x10mm	6	48

INDUSTRIAL

INDUSTRIAL

LAMA RICAMBIO PER TAGLIAPIASTRELLE 41032T



Materiale
TCT di alta qualità:
YG6X f15*f6*1.5mm
Adatto per stock
TOLSEN n.41032 e 41033

Codice	Misura	Pz/Conf	Master
41037T		10	200

TAGLIA PIASTRELLE DA 600mm TAGLIO 12mm

Tagliapiastrelle per impieghi gravosi 600 mm
Sostituisci le lame da taglio: f15 * f6 * 1,5 mm
Spessore di taglio massimo: 12 mm



LAMA RICAMBIO PER TAGLIAPIASTRELLE 41034T



Materiale
TCT di alta qualità:
YG6X
Adatto per codice
TOLSEN n. 41034

Codice	Misura	Pz/Conf	Master
41038T		5	50

Codice	Misura	Pz/Conf	Master
41032T	600mm	1	4

TAGLIA PIASTRELLE PROFESSIONALE DA 800mm TAGLIO 12mm

Tagliapiastrelle per impieghi gravosi 800 mm
Sostituisci le lame da taglio: f22 * f10,5 * 2 mm
Spessore di taglio massimo: 12 mm



**LAMA
LONG
LIFE**

Codice	Misura	Pz/Conf	Master
41034T	800mm	1	2



INDUSTRIAL

TAGLIA PIASTRELLE PROFESSIONALE DA 600mm TAGLIO 12mm

Tagliapiastrelle per impieghi gravosi 600 mm
Sostituisci le lame di taglio: f22 * f6 * 2MM
Taglia fino a 12 mm di spessore
Imballato da una scatola dei colori
Per tagli paralleli e angolati (0o-60o)
Gruppo di taglio pressofuso con cuscinetto a sfere Supporto a sfera scorrevole di grandi dimensioni spostamento delle piastrelle
Asta di arresto taglio di piastrelle in massa Profondità di taglio massima: 12 mm
Spessore della base: 1,8 mm
Punteggiatura: YG6X, f22 * f6 * 2 MM
Confezione: scatola colox



INDUSTRIAL

Codice	Misura	Pz/Conf	Master
41035T	600mm	1	2

CAZZUOLE PUNTA QUADRA



Diametro della biella: 9,5 mm
Manico in plastica bicomponente

GRIPPro
series

Codice	Misura	Pz/Conf	Master
41057T	180*90*115	12	48
41058T	200*90*120	12	48
41055T	140*85*107	12	72
41056T	160*88*115	12	72

CAZZUOLE PUNTA TONDA



Diametro della biella: 8 mm
Manico in plastica bicomponente

GRIPPro
series

Codice	Misura	Pz/Conf	Master
41061T	160mm	12	72
41063T	200mm	12	48
41062T	180mm	12	48

PISTOLA PER COLLA A CALDO 60W



Omologazione CE
Potenza: 15w
Voltaggio: 230v/50Hz
2 pezzi colla stick inclusa

Codice	Misura	Pz/Conf	Master
79105T	60W	10	40

PIALLATRICE PER CARTONGESSO 250mm



Dimensioni pialla a blocchi: 250 * 40 mm
Manico in plastica (ABS) con corpo in lega di alluminio

Codice	Misura	Pz/Conf	Master
42002T	250mm	5	40

PIALLATRICE PER CARTONGESSO IN PVC 250x40mm



Dimensioni pialla a blocchi: corpo in plastica
ABS 250 * 40 mm

Codice	Misura	Pz/Conf	Master
42003T	250x40mm	5	40

PISTOLA COLLA A CALDO PROFESSIONALI



Omologazione CE
Tensione nominale: 220-240 V
Frequenza: 50 Hz
Ugello in rame sostituibile
Con protezione da sovracorrente
Sistema anti-goccia

Codice	Misura	Pz/Conf	Master
38071T	60W - 11mm	5	30
38070T	20W - 7mm	6	48

LAMA RICAMBIO PER PIALLATRICE



Lunghezza: 250 mm, acciaio al carbonio, nero plat
Abbinato a 42003 + intestazione

Codice	Misura	Pz/Conf	Master
42008T		10	120

MATITA BI-COLORE ROSSO/BLU SET 12PZ



Matita da carpentiere (ovale) 10 * 7,5 * 176 mm
Dimensioni della mina: 4,0 * 2,0 mm
12 pezzi

Codice	Misura	Pz/Conf	Master
42022T		10	72

LAPIS DA CARPENTIERE SET 12Pz



Matita da carpentiere (ovale) 12 * 7,4 * 176 mm
Dimensioni della mina: 5,0 * 2,0 mm
12 pezzi
Confezionato in scatola colorata

Codice	Misura	Pz/Conf	Master
42021T		10	72

TRACCIALINEE 30mt CON LIVELLA EX 42011T



1 bobina di linea di gesso 30 m 3 volte la velocità di riavvolgimento più veloce
1 bolla di spirito 1 bottiglia di polvere blu: 115 g

Codice	Misura	Pz/Conf	Master
42013T	30mt	12	48

POLVERE TRACCIANTE



Peso: 225 g

Codice	Misura	Pz/Conf	Master
42018T	BLE	6	60
42017T	ROSSA	6	60

TAGLIAVETRO PROFESSIONALE 175mm



Taglierina per vetro per impieghi gravosi
Corpo in ferro
Sistema di alimentazione dell'olio automatico
Lama in carburo di tungsteno, Ideale per spessori del vetro da 4 a 10 mm
Lunghezza totale di taglio: 6000 m/
Lama ruota 1 pezzo
Lunghezza: 175 mm

Codice	Misura	Pz/Conf	Master
41029T	175mm	6	120

PENNARELLO INDELEBILE NERO



Colore nero 143 mm x F15 mm
Larghezza di scrittura: 2 mm
Confezione: 12 pezzi in una scatola di colore

Codice	Misura	Pz/Conf	Master
42025T		12	720

TAGLIA VETRO A ROTELLA 130mm



Tagliavetro (manico in legno)
Con 6 ruote lama
TCT; 130 mm
Finitura cromata

Codice	Misura	Pz/Conf	Master
41030T	130mm	6	240

TAGLIA VETRO DI PRECISIONE DIAMANTATO 178mm



Tagliavetro (manico in plastica) 178 mm
Lama
TCT di alta qualità

Codice	Misura	Pz/Conf	Master
41031T	178mm	6	240

PISTOLA PER SILICONE EASY



9"/225mm
Acciaio stampato, barra di spinta del cambio

Codice	Misura	Pz/Conf	Master
43042T	225mm	24	24

PISTOLA PER SILICONE IN ALLUMINIO



Corpo tubo in alluminio con spingitore albero
Coperchio in alluminio
Dado di bloccaggio in alluminio
Maniglie in alluminio per impieghi gravosi

Codice	Misura	Pz/Conf	Master
43044T	225mm	6	12
43046T	375mm	6	12

PISTOLA PER SILICONE TIPO INGLESE



Corpo in alluminio, grilletto in acciaio

Codice	Misura	Pz/Conf	Master
43041T	225mm	24	24

BECCUCCIO RICAMBIO PISTOLA PER SILICONE



Materiale: polipropilene
Adatto per codice TOLSEN n. 43044 e 43046
5 pezzi confezionati in un sacchetto di plastica

Codice	Misura	Pz/Conf	Master
43048T		5	40

PISTOLA PER SILICONE TIPO PROFESSIONALE



Corpo in alluminio, grilletto in acciaio

Codice	Misura	Pz/Conf	Master
43049T	225mm	6	24

NASTRO TELATO GRIGIO



Misura: 48 mm x 25 m
Elevata resistenza alla trazione
Facile da strappare a mano.
Progettato per la protezione rinforzata di vari tubi e oggetti, imballaggi pesanti, giunti di moquette e apposizione

Codice	Misura	Pz/Conf	Master
50281T	48 mm x 25m	36	36

PISTOLA PER SCHIUMA POLIURETANICA

Tigger in metallo con corpo in lega di alluminio, design resistente.
Ago in acciaio inossidabile
La vite di regolazione fa fluire la schiuma in modo fluido
Testato individualmente dalla pressione dell'aria



Codice	Misura	Pz/Conf	Master
43060T		5	20

RETE IN FIBRA DI VETRO



Elevata resistenza alla trazione, buona capacità di adesione
Resistenza acido-alcaina, resistenza alla corrosione
Posizionamento eccellente

Codice	Misura	Pz/Conf	Master
50269T	20mt	60	60
50270T	45mt	6	36
50271T	90mt	6	24

CRIMPATRICE PER PROFILI IN ALLUMINIO 275MM

Dimensioni: 270 mm
lega di alluminio pressofuso
testa in acciaio al carbonio
Manico rivestito in PVC a tre strati Ideale per fissaggio profili metallici per cartongesso



NEW

Codice	Misura	Pz/Conf	Master
10309T	275mm	6	24

PISTOLA TERMICA 1000/2000W

Omologazione CE
Tensione: 230V-50HZ
2 range di temperatura regolabili:
1 = 1000w, 300L/min
2 = 2000w, 500L/min
Accessori:
1 ugello a punta
1 ugello di inversione
1 ugello grandangolare
1 ugello di protezione del bordo.

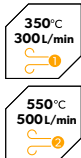

Codice	Misura	Pz/Conf	Master
79100T	1000/2000w	5	10

RUOTA PNEUMATICA 16"



Dimensioni: 16"x4"-8
4PR, Pneumatico con linee diamantate
Cuscinetto a sfera

NEW

Codice	Misura	Pz/Conf	Master
62635T	16"x4"-8	1	5

VENTOSA SINGOLA 25KG



25 kg
Corpo in plastica
Diametro tazza: 11,5 cm

Codice	Misura	Pz/Conf	Master
62661T	25kg	6	24

VENTOSA DOPPIA 50KG



50 kg
Con due ventose
Corpo in plastica
Diametro tazza: 11,5 cm

Codice	Misura	Pz/Conf	Master
62662T	50kg	6	12

VENTOSA TRIPLA 75KG



75 kg
Con tre ventose
Corpo in plastica
Diametro tazza: 11,5 cm

Codice	Misura	Pz/Conf	Master
62663T	75kg	2	10

RUOTA PIENA 16"



Dimensioni: 16"x4"-8
Cuscinetto a sfera

NEW

Codice	Misura	Pz/Conf	Master
62636T	16"x4"-8	1	5

TOLSEN GARDEN



TOLSEN

UTENSILI DA GIARDINO



SEGACCIO DA POTA PIEGHEVOLE 180mm

180mm
Lama 7TPI 65Mn
Con manico in plastica bicomponente



Codice	Misura	Pz/Conf	Master
31014T	180mm	6	24

FORBICI DA POTA IN ACCIAIO MANICO LEGNO



Dimensioni: 220 mm
Capacità di taglio spigolo vivo: 19 mm
Lama in acciaio al carbonio di alta qualità
Superficie finemente levigata
Manico in legno di pero rosso, finemente lucidato



NEW

Codice	Misura	Pz/Conf	Master
31033T	220mm	5	60

FORBICI DA GIARDINO 200mm



8"
Manico ad immersione finemente lucidato



Codice	Misura	Pz/Conf	Master
31018T	200mm	5	60

FORBICI DA POTA 200mm



lama SK5 da 8" Manico ad immersione



INDUSTRIAL

SK5

Codice	Misura	Pz/Conf	Master
31022T	200mm	5	60

FORBICI DA VIGNA 200mm



8"
Lucidato a specchio
Manico ad immersione



Codice	Misura	Pz/Conf	Master
31019T	200mm	5	60

FORBICI DA POTA IN ALLUMINIO TAGLIO BATTENTE 200mm



lama da 8" 65Mn rivestita in teflon



Codice	Misura	Pz/Conf	Master
31023T	200mm	5	60

FORBICI DA POTA 200 MM



Lama da 65Mn
Manico in plastica
Imballaggio: blister



Codice	Misura	Pz/Conf	Master
31020T	200mm	5	60

FORBICI DA POTA TAGLIO BATTENTE 200 MM



Taglia: 8"
Lama da 65Mn
Manico in plastica
Imballaggio: blister



Codice	Misura	Pz/Conf	Master
31021T	200mm	10	60

FORBICI DA POTTA LAME DRITTE ACCIAIO INOX



200mm(8")
Lama in acciaio inossidabile, finemente lucidata
Manico in lega di zinco, con impugnature in PVC
Imballaggio: blister



NEW



Codice	Misura	Pz/Conf	Master
31031T	200mm	6	60

CESOIA DA POTTA ACCIAIO INOX



200mm(8")
Lama in acciaio inossidabile, finemente lucidata
Manico in lega di zinco, con impugnature in PVC
Imballaggio: blister



NEW



Codice	Misura	Pz/Conf	Master
31032T	200mm	6	60

TAGLIA RAMI TELESCOPICA 61-91cm

Manico telescopico in tubo d'acciaio
impugnature in PVC



Codice	Misura	Pz/Conf	Master
31025T	61-91cm	3	12

TAGLIA SIEPI TELESCOPICA 61-91cm

Manico telescopico in tubo d'acciaio
impugnature in PVC



Codice	Misura	Pz/Conf	Master
31024T	61-91cm	3	12

SEGACCIO DA POTTA 350MM

350 mm
Lama 7TPI 65Mn
Con manico in plastica bicomponente



Codice	Misura	Pz/Conf	Master
31045T	350mm	5	40

SEGACCIO DA POTTA 350MM

Lama 7TPI 65Mn
Con manico in plastica bicomponente, fodero rigido



Codice	Misura	Pz/Conf	Master
31046T	350mm	5	40

ASTA TELESCOPICA PER SEGACCIO 31048T

Materiale in ferro di alta qualità con superficie verniciata a polvere gialla. Contrazione a due sezioni. Lunghezza di espansione: 2,4 m. Lunghezza retratta: 1,29 m. Può essere bloccato a qualsiasi lunghezza. Adatto per TOLSEN 31048



Codice	Misura	Pz/Conf	Master
31049T	1.2-2.4mt	5	10

SEGACCIO 300MM PER ASTA TELESCOPICA



Lama da 65Mn e tripla dentatura rettificata
Lunghezza lama: 300mm
Lama,
Diametro massimo di taglio: 35mm
: corda in nylon



Codice	Misura	Pz/Conf	Master
31048T	300mm	5	10

SEGHE

lama da 400 mm 7TPI 65Mn, trattata termicamente



Codice	Misura	Pz/Conf	Master
31070T	40cm	5	40
31072T	50mm	5	40

SEGA AD ARCO 530mm

Maniglia per seghetto a mano 530 mm
Include 1 lama per sega



Codice	Misura	Pz/Conf	Master
31081T	530mm	6	18

CARRELLO AVVOLGITUBO COMPACT PER TUBI FINO A 45MT



Materiale: PP
Adatto per tubi di dimensioni fino a 1/2" x 45 m
Impugnatura pieghevole
Semplice montaggio a scatto e blocco

Codice	Misura	Pz/Conf	Master
57221T	45mt	1	5

TUBO ESPANDIBILE DA 5 A 15 MT



Dimensioni: 5 m - 15 m
Super leggero e facile da riporre
Il tubo si espanderà mentre lo allunghi
Nessuno attorcigliamento
8 modalità di regolazione degli ugelli, portagomma 1/2"-3/4"
Imballaggio: scatola

Codice	Misura	Pz/Conf	Master
57250T	5-15 mt	1	12

LAME RICAMBIO PER SEGHE AD ARCO

21"
Denti abrasivi a doppio lato tipo A
Lama da 65Mn
Tempra ad alta frequenza



Codice	Misura	Pz/Conf	Master
31099T	530mm	10	200
31100T	610mm	10	200

LAMA PER SEGA AD ARCO DENTE A CASTELLO 530mm

21 "denti di rettifica a doppio lato tipo B
Lama da 65 Mn
Tempra ad alta frequenza



Codice	Misura	Pz/Conf	Master
31105T	530mm	10	200

GUANTI DA GIARDINAGGIO TG. 10



Taglia: 10 (XL)
Materiale: poliestere e cotone;
polso a maglia

NEW

Codice	Misura	Pz/Conf	Master
45006T	tg. 10 (XL)	12	10



PINZE RACCOGLIRIFIUTI



Tubo in lega di alluminio;
 Diametro tubo: 23,8 mm, spessore:
 0,8 mm
 Impugnatura ergonomica con blocco
 di sicurezza
 Ganasca in gomma antiscivolo per
 garantire una presa sicura
 Componenti in nylon

Codice	Misura	Pz/Conf	Master
50093T	870mm	6	12

ADATTATORE PER RUBINETTO 1/2" + 3/4"



1/2" + 3/4"
 Materiale:
 ABS

Codice	Misura	Pz/Conf	Master
57111T	1/2" + 3/4"	20	120

PISTOLA PER IRRIGAZIONE CON GETTO REGOLABILE



8 modalità selezionabili: pieno, angolo,
 doccia, nebbia, centro, piatto, cono,
 ammollo
 Corpo in
 ABS resistente con impugnatura comfort
 TPR

Codice	Misura	Pz/Conf	Master
57100T		12	48

CONNETTORE PER POMPA A 2 VIE 1/2"



1/2"
 Materiale:
 ABS

Codice	Misura	Pz/Conf	Master
57112T	1/2"	20	120

PISTOLA PER IRRIGAZIONE



Regolabile da nebulizzazione fine a
 getto potente
 Corpo in
 ABS resistente con impugnatura comfort
 TPR

Codice	Misura	Pz/Conf	Master
57101T		12	48

CONNETTORE PER POMPA A 3 VIE



1/2"
 Materiale:
 ABS

Codice	Misura	Pz/Conf	Master
57113T	1/2"	20	120

LANCIA PER IRRIGAZIONE



Regolabile da nebulizzazione fine a
 getto potente
 Corpo in
 ABS resistente con materiale
 PP
 Adattatore di connessione rapida
 globale

Codice	Misura	Pz/Conf	Master
57102T		12	96

RUBINETTO A 2 VIE CON DOPPIA VALVOLA



1/2"
 Materiale:
 ABS +
 PP

Codice	Misura	Pz/Conf	Master
57116T	1/2"	20	120

SET 4PZ CONNETTORI E LANCIA PER POMPA DA 3/4"



1 connettore per tubo da 3/4" 1 connettore per tubo da 3/4" con arresto dell'acqua 1 adattatore per rubinetto da 3/4" 1 ugello regolabile da 3/4"

Codice	Misura	Pz/Conf	Master
57171T	3/4"	12	48

SET 4PZ IRRIGAZIONE 1/2"



1pz 1/2" connettore per tubo 1pz 1/2" connettore per tubo con arresto dell'acqua 1pz 1/2" adattatore per rubinetto 1pz 1/2" ugello regolabile

Codice	Misura	Pz/Conf	Master
57125T	1/2"	12	48

CONNETTORE POMPA CON SISTEMA ACQUA STOP 1/2"



1/2"
Materiale:
PP +
ABS

Codice	Misura	Pz/Conf	Master
57117T	1/2"	20	120

IRRIGATORE PER PRATO



Irrigatore a impulsi in plastica con punta di zinco
Funzionamento circolare o parziale
La copertura dello spruzzo è fino a 24 metri di diametro
Materiale: ottone, lega di zinco

Codice	Misura	Pz/Conf	Master
57130T		6	48

CONNETTORE PER POMPA 1/2



1/2"
Materiale:
ABS +
PP

Codice	Misura	Pz/Conf	Master
57118T	1/2"	20	120

ADATTATORE PER RUBINETTO 3/4" + 1"



3/4 "+ 1"
Materiale:
ABS

Codice	Misura	Pz/Conf	Master
57160T	3/4"+1"	20	120

CONNETTORE CON INNESTO RAPIDO DA 1/2"



1/2"
Materiale:
PP +
ABS

Codice	Misura	Pz/Conf	Master
57119T	1/2"	20	120

CONNETTORE PER POMPA 3/4"



3/4"
Materiale:
PP +
ABS

Codice	Misura	Pz/Conf	Master
57163T	3/4"	20	120

CONNETTORE POMPA CON SISTEMA ACQUA STOP 3/4"



3/4"
Materiale:
PP +
ABS

Codice	Misura	Pz/Conf	Master
57164T	3/4"	20	120

GIUNTO PER POMPA 3/4"



3/4"
Materiale:
PP +
ABS

Codice	Misura	Pz/Conf	Master
57165T	3/4"	20	120

INNESTO PER RUBINETTO A 2 VIE 3/4"



3/4 "+ 1"
Materiale:
PP +
ABS

Codice	Misura	Pz/Conf	Master
57168T	3/4"	20	120

CARRELLO AVVOLGITUBO AUTOMATIC DA PARETE COMPLETO DI TUBO

Oversize: 53x49x23 cm

Adatto a tubi di dimensioni fino a 1/2"x15 M

Il tubo può essere bloccato a qualsiasi lunghezza

Con funzione di retrazione lenta

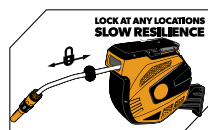

Codice	Misura	Pz/Conf	Master
57261T	53x49x23	1	1

POMPA IRRORATRICE SPRAY 2LT



2L
Materiale:
PE
Ugello in ottone
Pressione massima di esercizio: 2,0 Bar

Codice	Misura	Pz/Conf	Master
57281T	2lt	6	12

POMPA IRRORATRICE A SPALLA 16L

Capacità 16L

Pressione di esercizio: 0,2-0,4 MPa

Corsa operativa: 0-70 mm

Corpo in PE Accessori in PP

Bocca irroratrice in vetroresina

Con cintura

Tubo in PVC da 1,5 m

Peso netto: 2,85 kg

Imballaggio: scatola



POMPA IRRORATRICE A SPALLA 5LT



5L
Materiale:
PE
Con cintura
Pressione massima di esercizio: 2,5 Bar

Codice	Misura	Pz/Conf	Master
57292T	5lt	3	6

Codice	Misura	Pz/Conf	Master
57295T	16 Litri	1	1

SCOPA 9 DENTI DA GIARDINO



155 mm 9 denti
Dimensioni di ciascun dente: 6,0x1,0 mm
Acciaio speciale per utensili forgiato a goccia
Verniciato a polvere nero
Larghezza: 350 mm
Spessore: 2,5 mm
Manico in plastica bicomponente

GRIPPro
series

Codice	Misura	Pz/Conf	Master
57510T	155-350mm	10	60

ZAPPETTA TRIDENTE/QUADRO



Dimensioni della zappa: 65x90 mm
Dimensioni della forcella: 90x92 mm
Acciaio speciale forgiato per utensili
Verniciato a polvere nero
Lunghezza totale: 310 mm
Diametro dell'asta principale: 8 mm
Manico in plastica bicomponente

GRIPPro
series

Codice	Misura	Pz/Conf	Master
57508T	65x90mm	6	48

RASTRELLO IN PLASTICA

Rastrello in plastica a 22 denti
Larghezza: 510 mm
Fissato al manico in legno naturale:
120 cm
Lunghezza totale: 1580 mm

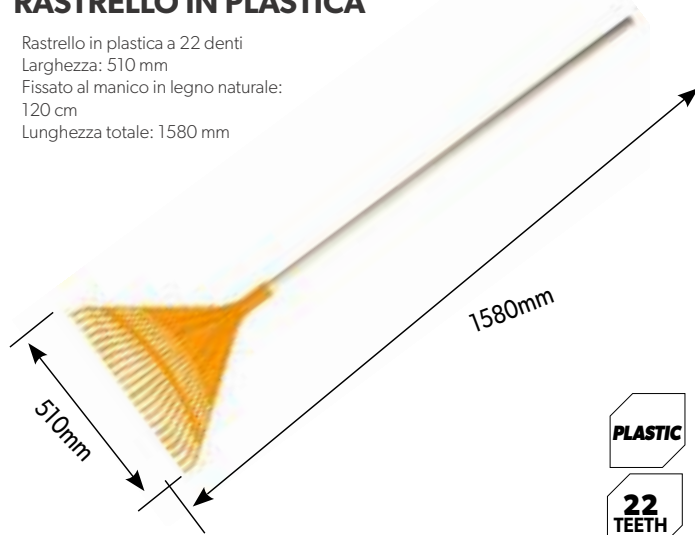

PLASTIC

22
TEETH

Codice	Misura	Pz/Conf	Master
57550T	510x120x1580mm	3	18

PALETTA DA GIARDINO



80 * 152 mm
Acciaio speciale forgiato a goccia
Verniciato a polvere nero
Lunghezza totale: 330 mm
Spessore: 1,5 mm
Manico in plastica bicomponente

GRIPPro
series

Codice	Misura	Pz/Conf	Master
57500T	80x152mm	10	60

TRAPIANTATRICE DA GIARDINO



55 * 152 mm
Acciaio speciale forgiato a goccia
Verniciato a polvere nero
Lunghezza totale: 330 mm
Spessore: 1,5 mm
Manico in plastica bicomponente

GRIPPro
series

Codice	Misura	Pz/Conf	Master
57502T	55x152mm	10	60

RASTRELLO IN METALLO FLESSIBILE

Acciaio al carbonio di alta qualità
Superficie verniciata a polvere 24 denti
Larghezza testa: 580 mm
Lunghezza testa: 40 cm
Lunghezza totale: 1700 mm
Manico in legno finemente lucidato:
F25x1370 mm

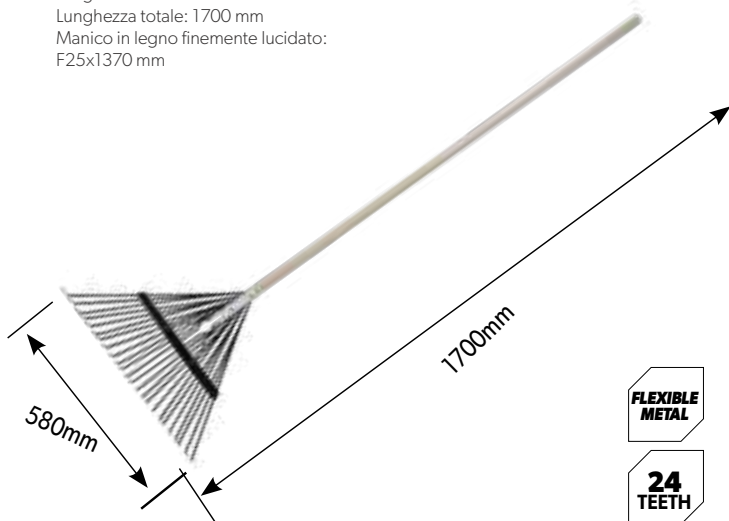

FLEXIBLE
METAL

24
TEETH

Codice	Misura	Pz/Conf	Master
57555T	580x40x1700mm	3	12

SARCHIATORE DA GIARDINO



55x90 mm
Acciaio speciale per utensili forgiato a goccia
Verniciato a polvere nero
Lunghezza totale: 285 mm
Diametro asta principale: 8 mm
Manico in plastica bicomponente

GRIPPro
series

Codice	Misura	Pz/Conf	Master
57504T	55x90mm	10	60

FORCHETTA DA GIARDINO



76x120 mm
Acciaio speciale forgiato a goccia
Verniciato a polvere nero
Lunghezza totale: 320 mm
Spessore: 2,5 mm
Manico in plastica bicomponente

GRIPPro
series

Codice	Misura	Pz/Conf	Master
57506T	76x120mm	10	60

VANGA A PUNTA CON IMPUGNATURA

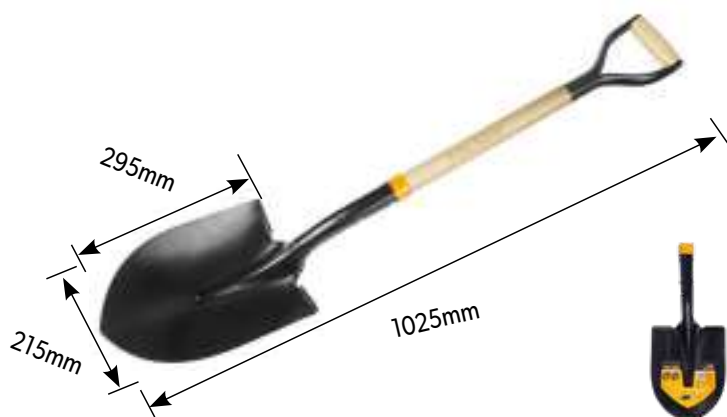

Manico in legno Lunghezza: 1020mm

Peso pala: 1 kg
Larghezza testa pala: 215mm

Lunghezza testa pala: 290mm

Materiale: acciaio al carbonio

Codice	Misura	Pz/Conf	Master
58001T	215X290X1020mm	6	6

BADILE IN ACCIAIO CON IMPUGNATURA

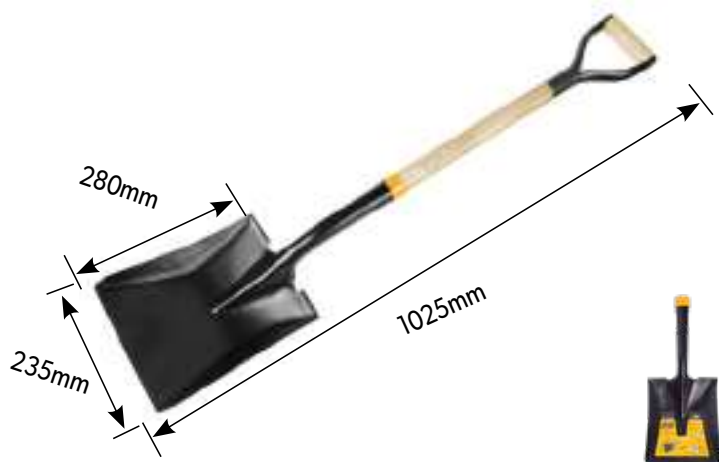

Manico in legno

Lunghezza: 1020mm

Peso pala: 1 kg
Larghezza testa pala: 280mm

Lunghezza testa pala: 235mm

Materiale: acciaio al carbonio

Codice	Misura	Pz/Conf	Master
58002T	235X280X1020mm	6	6

VANGA A PUNTA MANICO IN LEGNO

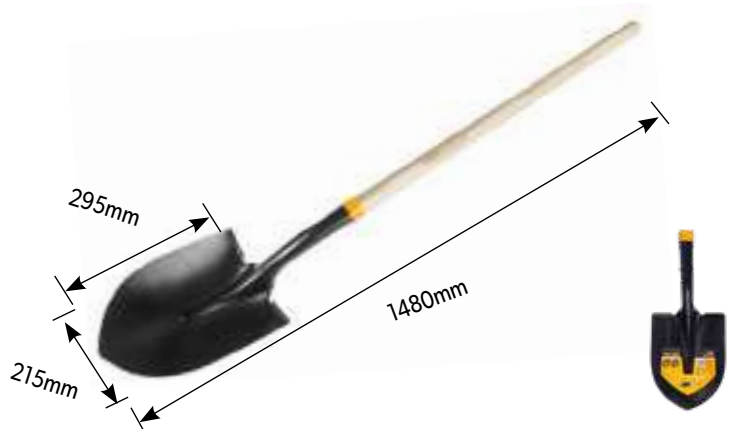

Manico in legno Lunghezza: 1470mm

Peso pala: 1 kg
Larghezza testa pala: 215mm

Lunghezza testa pala: 290mm

Materiale: acciaio al carbonio

Codice	Misura	Pz/Conf	Master
58005T	215X290X1470mm	6	6

BADILE MANICO IN LEGNO



Manico in legno

Lunghezza: 1470mm

Peso pala: 1 kg
Larghezza testa pala: 280mm

Lunghezza testa pala: 235mm

Materiale: acciaio al carbonio

Codice	Misura	Pz/Conf	Master
58006T	235X280X1470mm	6	6

FILO DECESPUGLIATORE TONDO



Dimensioni: 2,4 mm x 15 m / 0,095 " x 50ft
Materiale: nylon
colore arancio



Codice	Misura	Pz/Conf	Master
77654T	2.4mm x 15mt	10	120

FILO DECESPUGLIATORE TONDO



Dimensioni: 3.0 mm x 15 mt / 0,12 " x 50ft
Materiale: nylon
Colore giallo



Codice	Misura	Pz/Conf	Master
77658T	3.0mm x 15mt	10	120

FILO DECESPUGLIATORE QUADRO



misura: 2.4mm x 15mt / 0.095" x 50ft
Materiale: Nylon
colore: arancio



Codice	Misura	Pz/Conf	Master
77655T	2.4mm x 15mt	10	120

FILO DECESPUGLIATORE QUADRO



Dimensioni: 3.0 mm x 15 mt / 0,12 " x 50 ft
Materiale: nylon
Colore giallo



Codice	Misura	Pz/Conf	Master
77659T	3.0mm x 15mt	10	120

RASAERBA ELETTRICO 1400W - 35LT

Omologazione CE
Potenza in ingresso: 1400 W
Tensione nominale: 220-240 V
Frequenza: 50/60Hz
Tipo di guida: spinta manuale
Velocità a vuoto: 3400 giri/min
Motore a spazzole di carbone
Larghezza di taglio: 330 mm
Altezza di taglio: 30-75 mm (5 posizioni)
Dimensioni del sacco per erba: 35 Lt
Dimensione ruota anteriore: 140 mm
Dimensione ruota posteriore: 200 mm



Codice	Misura	Pz/Conf	Master
79626T	1400W	1	1

TOLSEN

CASSETTE E BORSE PORTAUTENSILI



BORSA PORTAUTENSILI 43cm



17"
Telaio rigido per un'apertura e un accesso facili
Partizione speciale delle tasche interne ed esterne, facile accesso al vano porta attrezzi
Tracolla regolabile inclusa
Scatola in tessuto leggero

INDUSTRIAL



Codice	Misura	Pz/Conf	Master
80101T	43cm	1	10

BORSA PORTAUTENSILI CON CHIUSURA A STRAPPO E MANICO IN ACCIAIO 43cm



17"
Partizione speciale delle tasche interne ed esterne, facile accesso al vano attrezzi
Manico in acciaio
Tracolla regolabile inclusa
Design speciale a doppio fondo
Patta di chiusura

INDUSTRIAL



Codice	Misura	Pz/Conf	Master
80102T	43cm	1	4

ZAINO PORTAUTENSILI



Materiale: nylon
Capacità: 38,4 litri 32 cm * 25 cm * 48 cm
Peso: 1,12 kg



Codice	Misura	Pz/Conf	Master
90009T	32x25x48cm	1	4

CINTURA PORTAUTENSILI



Con 11 tasche
1pz anello martello ,
1pz chiusura nastro di misurazione
Cinghia regolabile



Codice	Misura	Pz/Conf	Master
80120T		3	20

BORSA PORTAUTENSILI BASE RINFORZATA



16"
Telaio rigido per un'apertura e un accesso facili
Base in plastica rinforzata per una maggiore durata
Partizione speciale delle tasche interne ed esterne, facile accesso al vano porta attrezzi

INDUSTRIAL



Codice	Misura	Pz/Conf	Master
80103T	40cm	1	6

BORSA PORTAUTENSILI APERTA CON MANICO IN ACCIAIO



17 "(42 * 21 * 29 cm)
Costruzione pieghevole
Con 8 supporti interni
Con 15 tasche
Tubo in acciaio inossidabile, manico in gomma piuma
Tracolla regolabile

INDUSTRIAL



Codice	Misura	Pz/Conf	Master
80112T	42cm	1	10

ZAINO PORTAUTENSILI



16 tasche combinate multifunzione con 1 portachiavi.
può ospitare un laptop da 15,4 pollici imbottiture posteriori a nido d'ape, spillacci traspiranti e regolabili. Realizzato in poliestere leggero impermeabile
Peso netto: 640 g
Massimo. capacità di carico: 8 kg



Codice	Misura	Pz/Conf	Master
80040T	30x12x44cm	1	6

SET 9PZ ATTREZZI MISTI



Contiene: flessometro 3mx16mm - cacciavite PH1 5x100mm - cacciavite a taglio 5.5 5x100mm - chiave regolabile 250mm - pinza trochese 160mm - pinza combinata 180mm - cutter - cercafase - nastro isolante



Codice	Misura	Pz/Conf	Master
85301T		1	10

CASSETTE IN PLASTICA

Scatola separata in PP
Peso netto: 670 g



INDUSTRIAL

Codice	Misura	Pz/Conf	Master
80190T	34cm	1	12
80201T	42cm	1	9

CASSETTE IN METALLO

Spessore acciaio: 0,6 - 0,8 mm
Peso netto: 3,0 kg
3 strati



INDUSTRIAL



Codice	Misura	Pz/Conf	Master
80211T	40cm	1	1
80212T	50cm	1	1

CASSETTA METALLICA COMPLETA DI 60 UTENSILI

Il set di utensili manuali da 60 pezzi contiene:
1 cassetta degli attrezzi 5 vassoi; 495x200x290 mm; 18 prese da 1/2" a 6 punti; CrV 50BV30; 8, 10, 11, 12, 13, 14, 15, 16, 17, 18, 19, 20, 21, 22, 24, 27, 30, 32 mm;
1 cricchetto reversibile da 1/2"; 45T; CrMo; Giunto universale 1pc 1/2"; CrV;
1 pinza per pompa dell'acqua 250 mm;
1 pinza di bloccaggio da 250 mm; CRV;
13 chiavi combinate; 8,10, 11, 12, 13, 14, 15, 16, 17, 18, 19, 22, 24mm;
7 cacciaviti; CRV;
SL3.0x75mm, SL5.5x100mm, SL6.5x150mm, SL8.0x150mm; PH1x100mm, PH2x150mm, PH3x150mm;
1 pinza per comination da 180 mm;
1 pinza a becco lungo 160 mm;
1 pinza taglierina diagonale 160 mm;
Set di chiavi esagonali a braccio lungo con punta a sfera da 9 pezzi; CRV;
1,5-2-2,5-3-4-5-6-8-10mm;

Codice	Misura	Pz/Conf	Master
85401T		1	1

CASSETTA 119pz ASSORTITI



Contiene: 1 pinza combinata: 160 mm, 6" 1 pinza a becchi lunghi: 160 mm, 6" 1 pinza per pompa dell'acqua: 250 mm, 10" 1 martello da carpentiere: 8 once 1 chiave regolabile: 200 mm, 8" 1 coltello a lama a scatto 70 set di chiodi: 10 pz chiodi in ferro 1,5" 10 pz chiodi in acciaio 1,5" 10 pz viti per truciolare 4x30mm 10 pz tappi a vite in plastica 5x25mm 10 pz tappi a vite in plastica 6x30mm 10 pz viti autofilanti ST2.9x25mm 10 pz viti autofilanti ST4.0x30mm 1 pz nastro di misurazione 3mx16mm 9 pz chiave esagonale a braccio lungo set 1.5/2/2.5/3/4/5/6/8/10mm 1 pz nastro isolante in PVC 0,13x19mmx9,15m (colore rosso) 1 pz telaio mini seghetto con lama 150mm, 6" 1 pz cacciavite a taglio 5,5x100mm 1 pz cacciavite phillips PH1x100mm 1 pz cacciavite dado 1/4"x100mm 1 pz tester di tensione: 3x140mm 20pz punte per cacciavite Cr-V 1/4"x25mm: T10, T15, T20,

Codice	Misura	Pz/Conf	Master
85350T		4	4

CASSETTA PORTATTREZZI COMPLETA DI 26 UTENSILI

Il set di 26 utensili manuali contiene: 1 pinza combinata da 180 mm, 7"; 5 chiavi combinate set 8/10/13/17/19 mm; 9 chiavi a brugola a braccio lungo set 1.5/2/2.5/3/4/5/6/8/10mm; 3pz Cacciavite a taglio 5,5x100mm; 6,5x150mm; 8,0x150mm; 3pz Cacciaviti Phillips PH1x100mm; PH2x150mm; PH3x150mm;



Martello da macchinista 300g;
1pz Coltello a lama a scatto 18mm;
1pz Nastro di misurazione 5mx19mm, MIDII; 1pz Guanti da giardino 10(XL);
1 pz Cassetta degli attrezzi in plastica resistente 420x230x190mm

Codice	Misura	Pz/Conf	Master
85361T	420x230x190mm	1	4



INDUSTRIAL



**SICUREZZA
EFFICIENZA
PRODUTTIVITÀ**



TOLSEN

UTENSILI PER ELETTRICISTI



FORBICI PER ELETTRICISTA 140mm



Lama in acciaio inossidabile 5,5"
Progettato per applicazioni
elettriche ed elettroniche



INDUSTRIAL

Codice	Misura	Pz/Conf	Master
30043T	140mm	12	120

CACCIAVITI POZIDRIV ISOLATI



Certificazione VDE
Impugnatura
confortevole
bicomponente

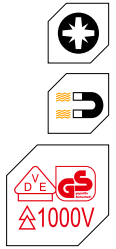

Codice	Misura	Pz/Conf	Master
38010T	PZ1X80	12	144
38011T	PZ2X100	12	72

SET 6PZ CACCIAVITI MISTI VDE



Codice	Misura	Pz/Conf	Master
38013T	3x75,4x100,5,5x100 PH1x 80,	5	20

CACCIAVITI FISSI ISOLATI



Certificazione VDE
Impugnatura confortevole
a due componenti

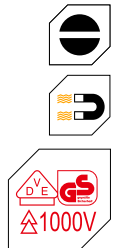

Codice	Misura	Pz/Conf	Master
38000T	3X75	12	144
38001T	4X100	12	144
38002T	5,5X125	12	144
38003T	6,5X150	12	72

CACCIAVITE VDE CON PUNTE INTERCAMBIABILI SET 13PZ

VDE/GS certificato 4pc certificato Slot:
1.2x6.5x100mm, 1x5.5x100mm,
0.8x4x100mmx0.5x3x100mm
2pcs Phillips 1 pz100mm



INDUSTRIAL



Codice	Misura	Pz/Conf	Master
38016T		1	12

CACCIAVITI PH ISOLATI



Certificazione VDE
Impugnatura
confortevole
bicomponente

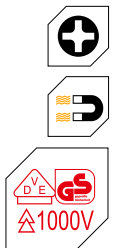

Codice	Misura	Pz/Conf	Master
38006T	PH1X80	12	144
38007T	PH2X100	12	72

TESTER DIGITALE IEC-61010 CAT II

IEC-61010 CAT II 3 1/2 cifre
 LCD, lettura max 1999 ·
 Ampio display LCD ·
 Indicazione di batteria scarica ·
 Protezione da sovraccarico ·
 Modalità di conservazione dei dati · Spegnimento automatico
SPECIFICHE
 Tensione CC: 200 m/2/20/200/250 V
 CA Tensione: 2/20/200/250 V
 CC Corrente: 400µ/2 m/20 m/200 m/10 A Corrente CA: 2 m/20 m/200 m/10 A
 Resistenza: 200/2 k/20 k/200 k/2 M/20 MO Controllo batteria: 1,5 V, Controllo diodo 9V: 2,8V/1mA

Codice	Misura	Pz/Conf	Master
38031T		3	20
			



INDUSTRIAL

UTENSILI PER ELETTRICISTI

MULTIMETRO DIGITALE A PINZA DIGITALE



Corrente CA: 2/20/200/400 A±(1,0%+9)
 Tensione CA: 2/20/200/600 V ± (1,2%+5)
 Tensione CC: 200 m/2/20/200/600 V±(0,8%+1)
 Resistenza: 2000/2kO/20kO/200kO/2M O/20MO±(1,0%+2)
 Controllo diodi circa: 1,5 V
 Dimensione: 210 * 75,6 * 30 mm, dimensione massima dell'apertura: 28 mm, Peso netto: 220 g, Batterie: 2 * AAA (1,5 V) incluse
 Puntale: spina curva nera e rossa
 Imballaggio: scatola

INDUSTRIAL

NEW

Codice	Misura	Pz/Conf	Master
38034T	210x75.6x30mm	3	20
			

PINZA SPELAFILI 0,5-6mm



Spelafili e taglierina 2-IN-1
 Dimensioni spelafili applicabili: 0,5 mm² - 6 mm²
 Il meccanismo autoregolabile in base alle dimensioni del filo fornisce un'eccellente spelatura del filo
 Arresto regolabile per uniformità nelle lunghezze delle strisce di filo, sistema di lame sostituibili
 Striscia applicabile anche cavo piatto di 8 mm di larghezza
 Semplice quadrante di regolazione della pressione della lama in base allo spessore dell'isolante card

Codice	Misura	Pz/Conf	Master
38050T	0,5-6mm	6	48
			

COLTELLO DA ELETTRICISTA 195MM



Lama curva
 Dimensioni: 195 mm, acciaio inossidabile speciale
 Spessore: 2,8 mm
 Manico in legno finemente lucidato
 Imballaggio: blister

INDUSTRIAL

NEW

Codice	Misura	Pz/Conf	Master
38041T	195mm	12	72
			

PINZA SPELACAVI / TAGLIACAVI DA 160mm



6"/160 mm
 Funzione di spelatura 7 in 1 0,6-2,6 mm, 22-10 AWG
 Con impugnatura e taglierina

INDUSTRIAL

Codice	Misura	Pz/Conf	Master
38051T	160mm	6	72
			

PINZA SPELAFILI AUTOMATICA



8"/200 mm
 Testa in lega di zinco Cr12MoV, HRC52-60°
 Superficie rifinita nera
 Manico in plastica bicomponente
 Calibro di spelatura: 24-10 AWG / 0,2-6 mm²
 Taglio/crimpatura: 22-10 AWG / 0,5-6 mm²
 Terminale non isolato: 12-10 AWG / 4-6 mm²
 Terminale non isolato: 16-14 AWG / 1,5-2,5 mm²
 Terminale non isolato: 22-18 AWG / 0,5-1 mm²
 Confezione: blister

INDUSTRIAL

NEW

Codice	Misura	Pz/Conf	Master
38048T	200mm	5	40
			

PINZA CRIMPATRICE / SPELACAVI A CRICCHETTO



Acciaio al carbonio con telaio temprato e temprato
 Superficie con finitura chimicamente nera
 Impugnatura ergonomica bicomponente PP/TPR
 Compatto e durevole
 Alloggiamento W/KEY nel supporto modulare 8P
 Taglia e spela il filo con un'unica operazione, facile ed efficiente
 Con spelafili tondo
 Per crimpare la spina modulare come segue:
 8P8C/RJ45, 8P6C, 8P4C, 8P2C; 6P6C/RJ12, 6P4C/RJ11, 6P2C

INDUSTRIAL

Codice	Misura	Pz/Conf	Master
38054T	185mm	5	50
			

TORCIA DA LAVORO A LED MAGNETICA DISPLAY 12PZ



Materiale:ABS+PVC:
 Voltaggio batteria da 4,5 V
 Tipo di batteria :3 batterie AA non incluse
 Sorgente LED: 24 LED
 Luminosità 40 lumen. Tempo di lavoro 10 ore.
 Dimensioni del prodotto da 124 g:
 210*58*30mm
 Impermeabile: IP62

Codice	Misura	Pz/Conf	Master
60015T		12	48

TORCIA DA TESTA CON 7 LED



Materiale principale: ABS
 Multifunzione: 1LED?3LED?7LED
 Luminosità: 25Lumen. Utilizzo: 3 batterie AAA non incluse

Codice	Misura	Pz/Conf	Master
60011T		5	60

TORCIA LED IN PLASTICA 121mm



Materiale:PP+PVC
 Tensione batteria : 3V
 Tipo di batteria: 2 batterie AA (NON incluse)
 Sorgente LED: 3 LED
 Luminosità:12 lumen, tempo di lavoro 16 ore.
 Dimensioni del prodotto da 65 g:F40*148 mm
 Impermeabile: IP62

Codice	Misura	Pz/Conf	Master
60020T	148mm	10	60

TORCIA LED IN PLASTICA 301mm



Materiale: PP + PVC
 Tensione batteria: 3 V
 Tipo di batteria: 2 batterie D (NON incluse)
 Sorgente LED: 7 LED
 Luminosità: 30 lumen
 Intervallo: 15 M
 Tempo di lavoro: 30 ore
 Peso: 220 g
 Dimensioni prodotto: F70 * 208 mm
 Impermeabile: IP62

Codice	Misura	Pz/Conf	Master
60021T	208mm	6	48

TORCIA LED ALLUMINIO CON ZOOM 1501mm



Torcia a LED, 3 watt CREE
 Materiale principale: alluminio
 Tensione batteria: 4,5 V
 Tipo di batteria: 3 batterie AAA non incluse
 Luminosità: 150 lumen.
 Tempo di lavoro 5 ore.
 Peso: 95 g
 Dimensioni prodotto: F34x110 mm Impermeabile: IP65



INDUSTRIAL

Codice	Misura	Pz/Conf	Master
60033T	110mm	6	36

TORCIA LED MINI ALLUMINIO 501mm



Torcia a LED, 1 watt CREE
 Materiale principale: alluminio
 Tensione batteria: 1,5 V
 Tipo di batteria: 1 batterie AA non incluse
 Luminosità: 80 lumen. Tempo di lavoro 1,5 ore.
 Peso: 39 g
 Dimensioni prodotto: 20x97,5 mm
 Impermeabile: IP66

INDUSTRIAL

Codice	Misura	Pz/Conf	Master
60031T	97.5mm	5	60

TORCIA LED IN ALLUMINIO TELESCOPICA E MAGNETICA DISPLAY 12PZ



3 LED ultraluminosi 2 Magneti alle estremità della lampada,
 Collo flessibile,
 Corpo in alluminio 4 batterie Lr44
 3 colori disponibili

Codice	Misura	Pz/Conf	Master
66011T	17,5-57 cm	12	48

TORCIA LED ALLUMINIO CON ZOOM 5501mm



Torcia a LED, 5 watt CREE
 Materiale principale: alluminio
 Tensione batteria: 4,5 V
 Tipo di batteria: 3x3 Batterie non incluse
 Luminosità: 250 lumen.
 Tempo di lavoro 15 ore.
 Peso: 200 g
 Dimensioni prodotto: F38,5x212 mm
 Impermeabile: IP65

INDUSTRIAL

Codice	Misura	Pz/Conf	Master
60035T	212mm	1	24

CERCAFASE



Tensione di prova:
CA 100-500V
Certificato CE
Lampadina al neon

Codice	Misura	Pz/Conf	Master
38114T	140mm	24	480
38115T	190mm	24	480

CERCAFASE DIGITALE



Omologazione CE
Tensione di prova: 12 V - 250 V CA/CC
Dimensioni: 3,5x130 mm
display LCD
Test rapido della tensione
Confezione: blister

NEW

Codice	Misura	Pz/Conf	Master
38109T	3.5x130mm	12	96

SALDATORE ELETTRICO



Omologazione CE
Voltaggio: 230V ~ 50Hz
Potenza in ingresso: 30W
Tempo di preriscaldamento: 3~5minuti
Testa a punta

INDUSTRIAL



Codice	Misura	Pz/Conf	Master
38060T	30W	6	36
38063T	60W	6	36

LENTE PER SALDATORE USO LAVORI DI PRECISIONE



Diametro della lente in vetro: 62 mm
Un utile aiuto per lavori di saldatura o modellisti.
Morsetti regolabili a coccodrillo.
Il vano inferiore è dotato di piastra in acciaio che può migliorare la stabilità.
Utile per lavori di saldatura, orologi, riparazione di computer, creazione di gioielli o qualsiasi altro tipo di lavoro di precisione.

Codice	Misura	Pz/Conf	Master
38090T		6	24

GIACCA IMPERMEABILE



Materiale: 100% PVC
Spessore: 0,32 mm
Due tasche inferiori con patta

GILET MULTITASCHE PORTATTREZZI



Dimensioni: 510 x 600 mm
Scomparti per attrezzi.
Scomparti per oggetti personali.
Il materiale in rete consente il movimento dell'aria per il massimo comfort.
Spallacci regolabili per una vestibilità sicura.
Taglia unica

Codice	Misura	Pz/Conf	Master
80130T	UNICA	6	24

GILET CATARIFRANGENTE GIALLO



Approvato CE secondo EN471
Poliestere
Nastro riflettente alto 5 cm di larghezza

Codice	Misura	Pz/Conf	Master
45097T	L	4	16
45098T	XL	4	16
45099T	XXL	4	16

Codice	Misura	Pz/Conf	Master
45093T	XL	5	100
45094T	XXL	5	100

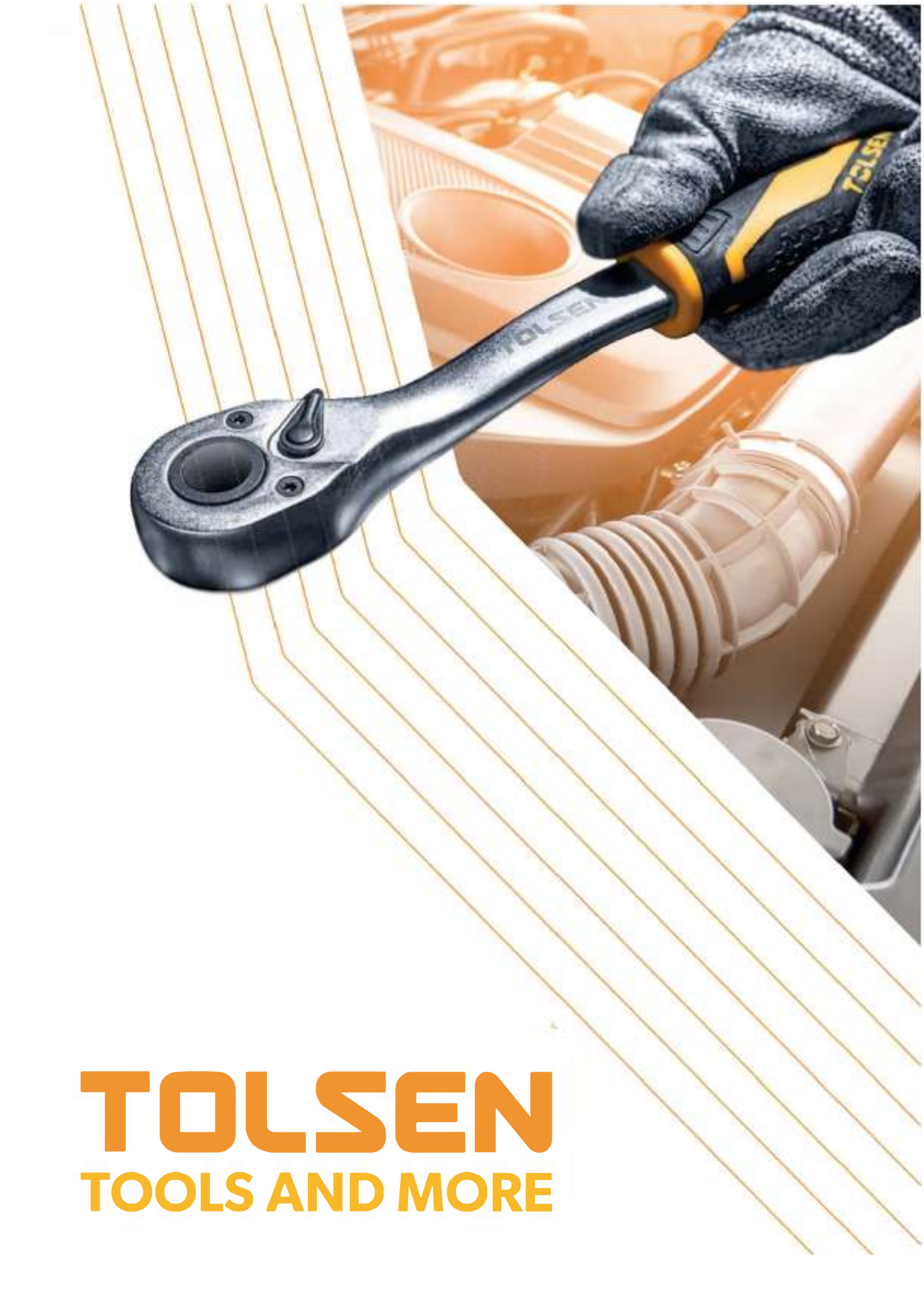

TOLSEN
TOOLS AND MORE

TOLSEN

UTENSILI DI FINITURA



LIMA PER FERRO PIATTA 200mm



Acciaio speciale per utensili
T12 piatto da 8"
Impugnatura in plastica bicomponente



GRIPPro
series



Codice	Misura	Pz/Conf	Master
32001T	200mm	10	100

LIMA PER FERRO QUADRATA 200mm



Acciaio speciale per utensili
T12 quadrato da 8"
Impugnatura in plastica bicomponente



GRIPPro
series



Codice	Misura	Pz/Conf	Master
32017T	200mm	10	100

LIMA PER FERRO MEZZA TONDA 200mm



Acciaio speciale per utensili
T12 semicircolare da 8"
Impugnatura in plastica bicomponente



GRIPPro
series



Codice	Misura	Pz/Conf	Master
32005T	200mm	10	100

RASPA PIATTA 200mm



8"
Piatto
Acciaio speciale per utensili
Manico in plastica bicomponente



GRIPPro
series



Codice	Misura	Pz/Conf	Master
32021T	200mm	10	100

LIMA PER FERRO TONDA 200mm



Acciaio speciale per utensili
T12 rotondo da 8"
Impugnatura in plastica bicomponente



GRIPPro
series



Codice	Misura	Pz/Conf	Master
32009T	200mm	10	100

RASPA MEZZA TONDA 200mm



8"
Mezzo tondo
Acciaio speciale per utensili
Manico in plastica bicomponente



GRIPPro
series



Codice	Misura	Pz/Conf	Master
32025T	200mm	10	100

LIMA PER FERRO TRIANGOLARE 200mm



Acciaio speciale per utensili
T12 triangolare da 8"
Impugnatura in plastica bicomponente



GRIPPro
series



Codice	Misura	Pz/Conf	Master
32013T	200mm	10	100

RASPA TONDA 200mm



8"
Tondo
Acciaio speciale per utensili
Manico in plastica bicomponente



GRIPPro
series



Codice	Misura	Pz/Conf	Master
32029T	200mm	10	100

SET 3PZ LIME PER FERRO



Piatto;
Mezzo tondo;
Rotondo
T12
Acciaio speciale per utensili
Manico in plastica
bicomponente

GRIPPro
series

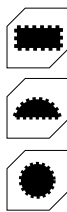

Codice	Misura	Pz/Conf	Master
32033T	200mm	5	40

SET 3Pz SPAZZOLE METALLICHE (NYLON-OTTONE-ACCIAIO)



1pz 180mm
Spazzola in nylon 1pz 180mm
Spazzola in acciaio 1pz 180mm
Spazzola inossidabile
Manico in plastica

Codice	Misura	Pz/Conf	Master
32059T	180mm	25	100

SET 3PZ RASPE



Piatto;
Mezzo tondo;
Rotondo
Acciaio speciale per utensili
Manico in plastica
bicomponente

GRIPPro
series

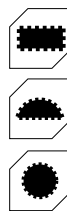

Codice	Misura	Pz/Conf	Master
32037T	200mm	5	40

SPAZZOLA FILI IN ACCIAIO 250mm TIPO SPID



Filo d'acciaio da 250 mm
Manico in plastica da appendere 24
pezzi in una scatola espositiva

Codice	Misura	Pz/Conf	Master
32060T	250mm	24	96

SPAZZOLA ACCIAIO DRITTA



4 linee
Filo dritto
Manico in legno

NEW

Codice	Misura	Pz/Conf	Master
32062T	4 linee	12	120

SPAZZOLA ACCIAIO RAMATO



4 linee
Filo ramato
Manico in legno

NEW

Codice	Misura	Pz/Conf	Master
32065T	4 linee	12	120

PIETRA PER AFFILARE



150x50x25mm
Ossido di alluminio grigio
Un lato: grana 120
Un lato: grana 240
Imballaggio: scatola bianca

Codice	Misura	Pz/Conf	Master
32047T	150x50x25mm	5	50

SET 5PZ LIME PER FERRO CON RASPA



8"
Lime in acciaio,
T12
Acciaio speciale per utensili
Piatte;
Mezza tonda;
Rotonda;
Triangolare;
Lima per legno,
Acciaio al carbonio
Mezza tonda;
Manico in plastica bicomponente



Codice	Misura	Pz/Conf	Master
32038T	200mm	4	16

SET 6PZ LIME MIGNON 3x100mm



3x100mm
Manico in plastica
bicomponente

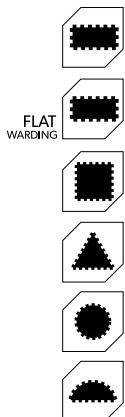

Codice	Misura	Pz/Conf	Master
32046T	3x100mm	10	100

TAMPONE IN PLASTICA PER LEVIGARE



Custodia in ABS
Piastra inferiore in EVA

PIALLATRICE MANUALE



Dimensioni: 235 x 44 mm
Materiale del manico: PP

Codice	Misura	Pz/Conf	Master
32100T	165x85mm	5	60
32101T	210x105mm	5	60

Codice	Misura	Pz/Conf	Master
42000T	235 x 44mm	6	24

TOLSEN

STRUMENTI DI MISURAZIONE



DOPPIO METRO IN LEGNO PIEGHEVOLE



Precisione: classe MID III
Corpo in legno finemente lucidato di alta qualità con molla
Imballaggio: custodia colorata

INDUSTRIAL

MIDIII

METRIC

Codice	Misura	Pz/Conf	Master
35046T	2mt	10	100

FLESSOMETRI LINEA EASY



MIDI

Lunghezza e larghezza: 3M*16mm
Con lama metrica
Precisione: Classe MID?
Lama con ritorno di potenza ha graduazioni chiare con rivestimento giallo resistente all'usura
Custodia in nastro di plastica
ABS con pulsante di bloccaggio e clip da cintura
Gancio terminale autoallineante per misurazioni interne/esterne accurate

Codice	Misura	Pz/Conf	Master
35991T	3X16mm	12	120
35992T	5 x 19mm	12	72
35994T	7,5 x 25mm	6	36

FLESSOMETRI IN POLLICI

Precisione fino alla classe MID 2
Materiale: custodia in ABS ricoperta di TPR
Sensazione di presa confortevole e resistente agli urti
Rivestimento in Nylon su entrambi i lati della lama
Pulsante di arresto potente manuale Con lama metrica e in "



MIDI

IMPUGNATURA IN TPR

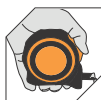

LAMA RIVESTITA IN NYLON



TERMINALE MAGNETICO



Codice	Misura	Pz/Conf	Master
36002T	3mt-10ft x 16mm	12	72
36004T	5mt-16ft x 16mm	8	48
36005T	8mt-26ft x 25mm	6	36
36006T	10mt-33ft x 25mm	6	36

RIGHELLO MISURAZIONE MULTIANGOLO

Una singola lunghezza di piega: 17,5 cm
Portatile e leggero per un facile trasporto, realizzato in robusta lega di alluminio premium, da utilizzare per molto tempo.
Uno strumento di misurazione del layout universale mentre si lavora su piastrelle, finitrici in mattoni, legname, laminato, legno, progetti di pavimentazione e altro ancora. Esegui l'upgrade con un design del localizzatore per aiutare a segnare la posizione e praticare il foro sulla piastrella di cui hai bisogno.
Unità di lunghezza su due lati: CM & Pollici
Strumenti di misurazione in metallo multifunzione per la costruzione, righello pieghevole a qualsiasi angolazione per soddisfare le tue esigenze quotidiane.



Ø45mm



Ø40mm



Ø25mm

Codice	Misura	Pz/Conf	Master
41045T		5	50

FLESSOMETRI

Precisione fino alla classe MID 2
Con lama metrica
Funzione autobloccante
Custodia in ABS ricoperta di TPR Sensazione di presa confortevole e resistente agli urti
Si blocca automaticamente, comodo da usare. con espositore



SUPER COATED

IMPACT RESISTANT

MIDI

SELF LOCK

Codice	Misura	Pz/Conf	Master
36012T	3X16mm	12	96
36014T	5X25mm	8	48
36016T	10X25mm	6	36

ROTELLE METRICHE



Lunghezza e larghezza: 30 mt x 12,5 mm - 100 ft x 1/2"
 Con lama in acciaio metrico e in pollici
 Ingranaggio retrattile in materiale puro
 Rapporto di trasmissione 4:1 per riavvolgimento rapido
 Cover in ABS
 Maniglia integrata
 Impugnatura ergonomica
 Imballaggio: scatola

NEW

Codice	Misura	Pz/Conf	Master
35013T	30mtx12.5mm	1	10
35014T	50mtx12.5mm	1	10

RIGHELLI IN ACCIAIO



Acciaio inossidabile (2Cr13)
 Dimensioni: 12"/300 mm
 Larghezza: 25 mm
 Spessore: 1,0 mm
 Imballaggio: sacchetto in PVC

NEW

Codice	Misura	Pz/Conf	Master
35026T	300mm	10	250
35028T	600mm	10	120

ROTELLE METRICHE



Custodia in ABS ricoperta di TPR
 Comoda sensazione di presa e resistente agli urti
 Con lama metrica
 Nastro in fibra di vetro con lama rivestita in PVC
 Quattro tempi di riavvolgimento rapido

INDUSTRIAL

Codice	Misura	Pz/Conf	Master
35017T	20mt x 15mm	5	40
35018T	30mt x 15mm	5	24
35019T	50mt x 15mm	5	16

FALSA SQUADRA



Corpo in fusione di zinco
 Lama in acciaio inossidabile
 Dimensioni metriche e in pollici,
 vite di regolazione in ottone,
 con livella e incisore

INDUSTRIAL

Codice	Misura	Pz/Conf	Master
35037T	250mm	8	48

SQUADRA IN ALLUMINIO 300mm



Corpo in acciaio inossidabile (2Cr13)
 Base in alluminio 300 mm
 Larghezza: 36 mm
 Spessore: 1,0 mm
 PVC

INDUSTRIAL

Codice	Misura	Pz/Conf	Master
35039T	300mm	5	60

ROTELLE IN POLLICI



Custodia in plastica
 ABS con impugnatura di avvolgimento a filo
 20 M / 66 piedi * 12,5 mm

Codice	Misura	Pz/Conf	Master
35022T	30mt-100ft x 12.5mm	5	40

SQUADRA DA FALEGNAME 300mm



12" / 300 mm
 Manico in alluminio
 Finitura verniciata a polvere
 PE

Codice	Misura	Pz/Conf	Master
35081T	300mm	5	120

CALIBRO VERNIER 0-150mm



Intervallo: 0-150 mm
 Precisione: 0,05 mm
 Acciaio al carbonio, cromato
 Misura a quattro vie
 Confezione: custodia in plastica con custodia colorata

Codice	Misura	Pz/Conf	Master
35048T	0-150mm	5	40

CALIBRO CENTESIMALE DIGITALE IN ACCIAIO

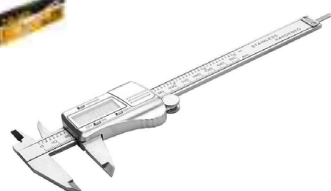

Sistema metrico e pollici
 Dimensioni: 0-150 mm
 Precisione: 0,01 mm
 Acciaio inossidabile
 Misurazione a quattro vie
 Imballaggio: custodia in plastica

NEW

Codice	Misura	Pz/Conf	Master
35053T	0-150mm	5	40

MICROMETRO MILLESIMALE



Range misurazione: 0-25 mm
 Precisione: 0,01 mm
 Superficie di misura in metallo duro
 Cornice cromata
 Arresto a cricchetto
 Imballaggio: custodia in plastica

NEW

Codice	Misura	Pz/Conf	Master
35055T	0-25mm	5	50

MINI LIVELLA 225mm EX 35059T



22,5 cm
 Materiale: alluminio con 3 bolle
 Imballaggio: manica colorata

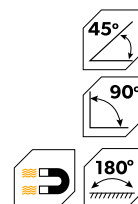

Codice	Misura	Pz/Conf	Master
35210T	225mm	10	60

LIVELLE MAGNETICHE

Livella (qualità industriale)
 Telaio in alluminio per impieghi gravosi
 Spessore: 1,5 mm
 Precisione: 0,5 mm / m
 Tre fiale: 90°, 180°, 45°
 Due superfici fresate
 Impugnatura in gomma umanizzata
 Tappi antiurto



INDUSTRIAL

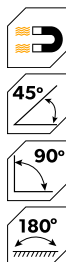

Codice	Misura	Pz/Conf	Master
35111T	40cm	5	20
35112T	60cm	5	20
35113T	80cm	5	20
35114T	100cm	5	20
35115T	120cm	5	20

LIVELLE IN ALLUMINIO NEW

40 cm, 16"
 Telaio in alluminio con lettura della scala
 Superficie verniciata a polvere
 Spessore: 1,0 mm
 Precisione: 1,0 mm/m
 Tre fiale: 90°, 180°, 45°

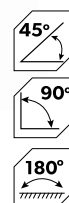

Codice	Misura	Pz/Conf	Master
35221T	40cm	5	50
35223T	60cm	5	50
35224T	80cm	5	30
35225T	100cm	5	30

LIVELLA LASER 120°- 20MT

Omologazione CE

Lunghezza d'onda: 635nm Luce rossa

Precisione del raggio: Linea H/V $\pm 3\text{mm}/10\text{m}$

Angolo: 120°

Massimo distanza d'esercizio: 20 mt

Alimentazione: batteria 2xAA (non inclusa)

Tempo di funzionamento: 4 ore

IP54 Temperatura di esercizio: $-10^{\circ}\text{C} - +50^{\circ}\text{C}$ Temperatura di stoccaggio: $-20^{\circ}\text{C} - +70^{\circ}\text{C}$

Caratteristiche:

Fornisce la massima visibilità della linea in condizioni di lavoro standard

Proietta linee verticali, orizzontali e trasversali. Le linee possono essere proiettate separatamente o insieme per una varietà di applicazioni di livellamento e allineamento. Si autolivella e indica una condizione fuori livello; si blocca quando è spento per un trasporto sicuro del laser. Modalità manuale — Blocca le linee per l'uso con qualsiasi angolazione.

Include un dispositivo di posizionamento con potenti magneti

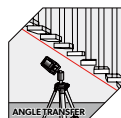
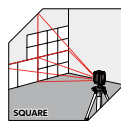
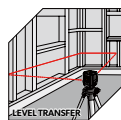
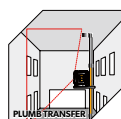
**LIVELLA LASER 360°- 30MT**

Omologazione CE

Lunghezza d'onda: 520nm Luce verde

Precisione del raggio: Linea H/V $\pm 3\text{mm}/10\text{m}$

Angolo: H&V 360°

Massima distanza di lavoro: 30 m (senza rilevatore)

Alimentazione: batteria 4xAA (non inclusa)

Tempo di funzionamento: 1C: 8h /2C: 4h

IP54 Temperatura di esercizio: $-10^{\circ}\text{C} - +50^{\circ}\text{C}$ Temperatura di stoccaggio: $-20^{\circ}\text{C} - +70^{\circ}\text{C}$

Caratteristiche:

Green Beam Laser —più luminoso dei raggi rossi standard

Due piani a 360°(orizzontale e verticale) — Per un'ampia gamma di applicazioni di allineamento orizzontale e verticale. Si autolivella e indica una condizione fuori livello; si blocca allo spegnimento.

Modalità manuale — Blocca le linee per l'uso con qualsiasi angolazione

Include dispositivo di posizionamento con potenti magneti

Imballaggio: custodia

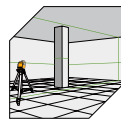
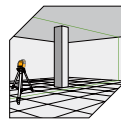
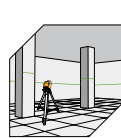
**NEW****NEW**

Codice	Misura	Pz/Conf	Master
35141T	120°-20 mt	1	12

Codice	Misura	Pz/Conf	Master
35154T	360°-30 mt	1	6

TREPIEDI PER LIVELLA LASER



NEW

Materiale: alluminio
 Altezza operativa massima:
 1425 mm, 56"
 Altezza chiusa 545 mm, 21,5"
 Manovella di regolazione, per
 una precisa regolazione
 dell'altezza
 Base stabile e regolabile
 Gambe pieghevoli
 Imballaggio: in una borsa di
 tela, rende il treppiede facile
 da trasportare e riporre.

1425 mm Max. height

545 mm Min. height

METRO LASER RANGE DA 2CM A 20MT

Intervallo di misurazione: 0,2 - 20 m 100 * 32,5 * 22 mm
 Funzioni:
 Misura la distanza
 Intervallo di misurazione: 20 metri
 Precisione di misurazione: ± 2 mm
 Tipo di batteria: 2 *
 AAA 1,5 V (non inclusa)
 Durata della batteria: 5000 misurazioni
 Caratteristiche della retroilluminazione: misura la
 distanza, - dimensioni ridotte, - estremamente facile da
 usare, - custodia in morbida gomma - perfetta per gli
 utenti del fai-da-te.

DISTANZA

AREA

VOLUME



Codice	Misura	Pz/Conf	Master
35165T	545mm - 1425 mm	1	10

Codice	Misura	Pz/Conf	Master
35172T	2cm-20mt	1	20

ASTA TELESCOPICA PER LIVELLE LASER



Quattro sezioni con altezza massima di
 3,85 m
 Piattaforma scorrevole
 Attacco filettato: 1/4" e 5/8"
 Imballaggio: borsa di tela + scatola

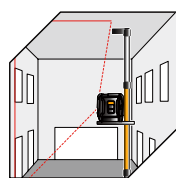

NEW

3.85M Max. height

1.23M Min. height

Codice	Misura	Pz/Conf	Master
35168T	1.23m - 3.85m	1	6

TOLSEN

UTENSILI PER SALDATURA



SUPPORTO MAGNETICO PER SALDATURA AD ANGOLO



Per trattenere i pezzi durante la saldatura o la saldatura
 Angoli di lavoro: 45°, 75°, 135° Prodotto in acciaio stampato di alta qualità con potente magnete



Codice	Misura	Pz/Conf	Master
44910T	11,5kg	6	48
44911T	23kg	5	30
44912T	35kg	2	18

PINZE PORTA ELETTRODO 500AH



Omologazione CE
 Materiale: ferro superiore, ottone inferiore
 Capacità di amplificazione: 500A
 Elettrodi da 3/32 "-5/16" (2,5 mm-8 mm)
 Lunghezza: 270 mm
 Include 2 chiavi esagonali

Codice	Misura	Pz/Conf	Master
44929T	500AH	5	25

GUANTI PER SALDATORI



Taglia: 14
 Materiale: pelle crosta di vitello

Codice	Misura	Pz/Conf	Master
45025T		12	72

GUANTI PER SALDATORI TIPO PROFESSIONALE



Taglia: 14
 Materiale:
 Pelle crosta di vitello
 Allungati per una migliore protezione

Codice	Misura	Pz/Conf	Master
45026T		12	48



DISPOSITIVI DI PROTEZIONE



GUANTO SPALMATO IN LATTICE TG.10



Polso lavorato a maglia;
Ottimo comfort e vestibilità.
Eccellente resistenza alla perforazione
sul palmo, lunga durata e assenza di
sudore.

NEW



Codice	Misura	Pz/Conf	Master
45016T	10	12	120

GUANTI DA LAVORO IN CROSTA DI VITELLO



Taglia: 10 (XL)
Materiale: crosta di vitello

Codice	Misura	Pz/Conf	Master
45024T	XL	12	72

GUANTI ANTITAGLIO



Fodera di livello 5 di resistenza al taglio
da 9" 13G con rivestimento in
PU sul palmo fodera in
HPPE senza cuciture



Codice	Misura	Pz/Conf	Master
45040T	9 / L	12	60
45041T	10 / XL	12	60

OCCHIALI DI PROTEZIONE PROFESSIONALI CON ELASTICO

Omologazione CE e ANSI.
Policarbonato resistente agli urti.
Offre una visione chiara e senza distorsioni.
Astinere regolabili.
Montatura in PA.



Codice	Misura	Pz/Conf	Master
45069T		5	80

GUANTI DA LAVORO MORBIDI PER MECCANICI



La vestibilità aderente aiuta a
mantenere le mani fresche e comode.
La costruzione del dito indice a doppia
cucitura migliora la durata.

Codice	Misura	Pz/Conf	Master
45044T	XL	12	72

GUANTI DA LAVORO PER MECCANICI RINFORZATI



L'imbottitura in schiuma
EVA assorbe e dissipa l'energia d'impatto,
protezioni per le nocche in
PVC, protezione per la punta delle dita.



Codice	Misura	Pz/Conf	Master
45047T	XL	12	72

VISIERA PROTETTIVA IN PLEXIGLASS



Copricapo
HDPE
Visiera in
PC, regolazione a cricchetto con fascia
antisudore per un maggiore comfort.

Codice	Misura	Pz/Conf	Master
45182T		5	40

OCCHIALI DI PROTEZIONE IN POLICARBONATO



Approvato CE e ANSI. Policarbonato resistente agli urti. Offre una visione chiara e senza distorsioni. Astine regolabili.

Codice	Misura	Pz/Conf	Master
45071T		10	100

GINOCCHIERE PER PIASTRELLISTI



Design professionale per un uso confortevole. Il materiale morbido e flessibile offre una buona protezione per le ginocchia.

Codice	Misura	Pz/Conf	Master
45106T		6	24

OCCHIALI DI PROTEZIONE IN PLASTICA TRASPARENTI



Approvato CE e ANSI. Design a vista completa. Resistente agli urti. Adatto per indossare gli occhiali correttivi.

Codice	Misura	Pz/Conf	Master
45072T		10	100

GINOCCHIERE PROFESSIONALI



Omologazione CE. Ginocchiere in schiuma spessa con cuscinetti effetto gel. Le imbottiture sono fissate con cinghie a strappo. Design professionale per un uso confortevole.

Codice	Misura	Pz/Conf	Master
45105T		4	16

OCCHIALI DI PROTEZIONE IN POLICARBONATO NERI



Realizzato in policarbonato ad alte prestazioni. Leggero, comodo da indossare, ampio campo visivo. Resistente agli urti. Imballo: busta di plastica.

Codice	Misura	Pz/Conf	Master
45073T		5	100

TAPPI PER ORECCHIE BOX 100 COPPIE



Approvato CE. Conforme alla struttura dell'orecchio, sicuro e igienico; Poliuretano espanso; effetto di riduzione del rumore superiore, consente agli operatori di mantenere l'udito acuto.

Codice	Misura	Pz/Conf	Master
45081T		1	20

OCCHIALI DI PROTEZIONE A MASCHERA CON ELASTICI



Approvato CE secondo EN166. Resistente agli urti. Montatura in PVC. Morbido e leggero con fori per l'aria. Lenti in policarbonato.

Codice	Misura	Pz/Conf	Master
45074T		10	100

CUFFIE PROTETTIVE



Approvato CE e ANSI, imbottito in schiuma offre una buona tenuta per la protezione dai rumori dannosi. SNR: 26dB, NRR=21dB.

Codice	Misura	Pz/Conf	Master
45083T		5	60

TOLSEN

VDELINE 

UTENSILI ISOLATI

PREMIUM

utensili professionali **VDE**



VDE si riferisce a Verband Deutscher Elektrotechniker in tedesco. Le attrezzature tecniche di lavoro e i materiali di consumo soggetti alle leggi applicabili sulla sicurezza dei dispositivi e dei prodotti recano il marchio **VDE-GS** che rappresenta la sicurezza del prodotto in relazione a rischi elettrici, meccanici, tossicologici, radiologici e di altro tipo. Inoltre, gli utensili con il marchio **VDE-GS** sono conformi alle norme **VDE** o alle norme europee o internazionalmente armonizzate, ovvero confermano la conformità ai requisiti di sicurezza delle rispettive linee guida:

 1000V

Doppio Triangolo e Range di Tensione

Se gli utensili o gli ausiliari isolati sono contrassegnati con il simbolo del triangolo doppio e le specifiche di tensione o campo o classe assegnate, sono adatti per lavorare sotto la tensione indicata:

DIN EN 60900 (IEC 60900)

Uno standard internazionale che, tra le altre cose, descrive in dettaglio la progettazione di strumenti isolati. Ad esempio, viene specificato lo spessore dell'isolamento protettivo. Inoltre, lo standard definisce i singoli test (test dei pezzi) nonché test di serie e campioni casuali per il controllo della sicurezza elettrica dell'isolamento protettivo.



TOLSEN

UTENSILI VDE PREMIUM



PINZE COMBINATE ISOLATE

PREMIUM



160mm, 6"
Certificazione VDE/GS
Prodotto secondo EN60900
Parte metallica in acciaio CRV
Superficie rifinita in nero e lucidata
Corpo lavorato di precisione con trattamento termico rigoroso
Manici pesanti isolati a due componenti con protezioni antiscivolo per maggiore comfort e sicurezza



Codice	Misura	Pz/Conf	Master
V16006T	160mm	6	36
V16007T	180mm	6	36
V16008T	200mm	6	36

PINZE BECCHI LUNGI CURVI ISOLATE

PREMIUM



160mm, 6"
Certificazione VDE/GS
Prodotto secondo EN60900
Parte metallica in acciaio CRV
Superficie rifinita in nero e lucidata
Corpo lavorato di precisione con trattamento termico rigoroso
Manici pesanti isolati a due componenti con protezioni antiscivolo per maggiore comfort e sicurezza



Codice	Misura	Pz/Conf	Master
V16026T	160 mm	6	36

PINZE SPELAFILI ISOLATE

PREMIUM



160mm, 6"
Certificazione VDE/GS
Prodotto secondo EN60900
Parte metallica in acciaio CRV
Superficie rifinita e lucidata in nero
Corpo lavorato di precisione con trattamento termico rigoroso
Testa a ganaschia lucidata a forma di V precisa rettificata con precisione con vite di bloccaggio regolabile per l'impostazione del diametro desiderato.
Can può essere utilizzato per fili pieni o intrecciati fino a 5 mm (10 mm²) di diametro
Impugnature isolate a due componenti pesanti con protezioni antiscivolo per maggiore comfort e sicurezza



Codice	Misura	Pz/Conf	Master
V16066T	160mm	6	36

PINZE TRONCHESI ISOLATE

PREMIUM



160mm, 6" certificato
VDE/GS
Prodotto secondo EN60900
Parte metallica realizzata in acciaio CRV
Superficie rifinita e lucidata di colore nero
Corpo lavorato di precisione con trattamento termico rigoroso
Giunto eccentrico ad alto effetto leva che rende il taglio di fili e cavi fino al 35% più facile per l'utente
Manici pesanti isolati a due componenti con protezioni antiscivolo per maggiore comfort e sicurezza



Codice	Misura	Pz/Conf	Master
V16036T	160 mm	6	36

PINZE BECCHI LUNGI ISOLATE

PREMIUM



160mm, 6"
Certificazione VDE/GS
Prodotto secondo EN60900
Parte metallica in acciaio CRV
Superficie rifinita in nero e lucidata
Corpo lavorato di precisione con trattamento termico rigorosamente
Le ganasce tonde piatte hanno superfici di presa seghettate
Manici isolati a due componenti pesanti con protezioni antiscivolo per un comfort extra e sicurezza card



Codice	Misura	Pz/Conf	Master
V16096T	160 mm	6	36
V16098T	200mm	6	6

PINZE TRONCHESI ISOLATE

PREMIUM



180mm, 7" certificato
VDE/GS
Prodotto secondo EN60900
Parte metallica realizzata in acciaio CRV
Superficie rifinita e lucidata di colore nero
Corpo lavorato di precisione con trattamento termico rigoroso
Giunto eccentrico ad alto effetto leva che rende il taglio di fili e cavi fino al 35% più facile per l'utente
Manici pesanti isolati a due componenti con protezioni antiscivolo per maggiore comfort e sicurezza



Codice	Misura	Pz/Conf	Master
V16037T	180mm	6	36

CACCIAVITI ISOLATI POZIDRIV PREMIUM

PREMIUM



PZO*60mm
Lama in materiale
S2 certificata
VDE/GS,
Impugnatura e manico realizzati
secondo
EN60900

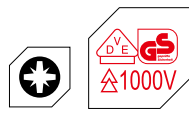

Codice	Misura	Pz/Conf	Master
V30600T	PZO*60mm	12	72
V30601T	PZ1*80mm	12	72
V30602T	PZ2*100mm	12	72
V30603T	PZ3*150mm	12	48

CACCIAVITI ISOLATI FISSI PREMIUM

PREMIUM



0,4*2,5*75 mm
Lama in materiale
S2 certificato
VDE/GS,

Impugnatura e manico realizzati
secondo
EN60900

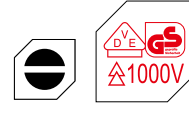

Codice	Misura	Pz/Conf	Master
V30204T	0,4*2,5*75mm	12	72
V30205T	0,5*3,0*100mm	6	72
V30206T	0,6*3,5*100mm	12	72
V30208T	0,8*4,0*100mm	6	72
V30210T	1,0*5,5*125mm	12	72
V30212T	1,2*6,5*150mm	12	72

SET 7PZ CACCIAVITI DI PRECISIONE ISOLATI (PREMIUM LINE)

PREMIUM



Contenuto: cacciaviti a taglio di
precisione isolati: 1,5 * 0,23 * 50 mm;
1,8*0,30*50 mm; 2,0*0,40*50 mm;
2,5*0,40*50 mm; 3,0*0,50*50 mm;
Cacciaviti phillips di precisione isolati:
PH0*50mm;
PH0*50mm;
Lama in materiale
S2 certificata
VDE/GS,
Impugnatura realizzata secondo
EN60900



Codice	Misura	Pz/Conf	Master
V32007T		1	20

SET 6PZ CACCIAVITI MISTI ISOLATI

cacciaviti isolati:0,4x2,5x75mm;0,8x4,0x100mm;1,0x5,5x125mm;

PH0x60mm;
PH1x80mm;
cercafase3,0x70 mm;
Certificazione
VDE/G EN60900

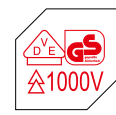

Codice	Misura	Pz/Conf	Master
V33506T		6	12

CACCIAVITI ISOLATI PHILLIPS PREMIUM

PREMIUM



PH0*60mm
Lama in materiale
S2 certificata
VDE/GS,
Impugnatura e manico realizzati
secondo
EN60900

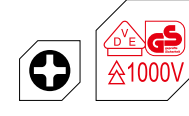

Codice	Misura	Pz/Conf	Master
V30400T	PH0*60mm	6	72
V30401T	PH1*80mm	6	72
V30402T	PH2*100mm	6	72
V30403T	PH3*150mm	12	48

CERCAFASE PROFESSIONALE

PREMIUM



3,0*70mm
Certificato VDE/GS

Prodotto secondo EN60900

Tensione di prova: AC 125 ~ 250V

Codice	Misura	Pz/Conf	Master
V70670T	3,0X70mm	6	72

SET 3PZ PINZE ISOLATE

Contenuto: pinza combinata isolata da 180 mm;
 Pinze a becchi lunghi isolati da 160 mm;
 Pinza da taglio diagonale isolata da 160 mm;
 Certificazione VDE/GS
 Prodotto secondo EN60900
 Parte metallica realizzata in acciaio CRV
 Superficie rifinita e lucidata in nero
 Corpo lavorato di precisione con trattamento rigorosamente termico
 Manici pesanti isolati bicomponente con protezioni antiscivolo per un maggiore comfort e sicurezza
 Imballo: borsa in tela



PREMIUM



Codice	Misura	Pz/Conf	Master
V83103T		1	10

SET 6PZ UTENSILI ISOLATI

Contenuto: pinza combinata isolata da 180 mm; Pinza da taglio diagonale isolata da 160 mm; Cacciavite a taglio isolato da 0,4 * 2,5 * 75 mm; Cacciavite isolato da 0,8 * 4,0 * 100 mm; Cacciavite Phillips isolato PH2*100mm; cercafase 30 * 70 mm;
 Certificato VDE/GS
 Prodotto secondo EN60900



PREMIUM



Codice	Misura	Pz/Conf	Master
V83306T		1	10

FORBICI PER ELETTRICISTA ISOLATE 160mm

Certificato VDE/GS
 Prodotto secondo EN60900
 Lama in acciaio inox, interamente bonificata;



PREMIUM



Codice	Misura	Pz/Conf	Master
V90047T	160mm	6	36

TOLSEN

ELETTROUTENSILI



CACCIAVITE A BATTERIA

Tensione nominale: 4 V CC
 Alimentazione: batteria da 3,7 V/2000 mAh
 Velocità a vuoto: 250/min
 Massimo. coppia: 10 / 5 N.m.
 Corrente di carica: 1A
 Mandrino: 1/4" (6,35 mm)
 Accessori: Cavo di ricarica di tipo C; Set di 16 punte Cr-V da 1/4"x25 (SL3, SL4, SL5, PH1, PH2, PH3, PZ1, PZ2, T10, T15, T20, T25, T30, H3, H4, H5)
 Set di 4 punte Cr-V da 1/4"x50mm (SL4, SL6, PH1, PH2)
 Portainserti magnetico 1/4"x65mm Cr-V
 3 luci da lavoro a LED, si accendono automaticamente durante il lavoro, illuminano la superficie di lavoro negli spazi bui
 Imballaggio: custodia in tela



Codice	Misura	Pz/Conf	Master
79005T	4V	6	12

MINI AVVITATORE A LITIO 3,6V

Omologazione CE
 Tensione: 3,6 V
 Alimentazione: Li-ion, 1300 mAh
 Velocità a vuoto: 180 giri/min
 Coppia massima: 3 Nm
 Mandrino: 1/4" (6,35 mm)
 Caricabatterie: AC100-240 V, 50/60 Hz
 Tempo di ricarica: 3-5 ore
 Interruttore: avanti e indietro 18 punte per cacciavite da 25 mm: PH0, PH1, PH2, PH2, PH3, PZ0, PZ2, PZ3
 Fissi: 3, 3,4, 4, 5mm
 Esagonale: H1.5, H4 *
 Torx : T8, T10, T15, T20
 2 punte per cacciavite da 50 mm: PH2
 Scanalatura: 4 punte elicoidali
 HSS da 3 pezzi: 2, 2,5, 3 mm 1 porta punte magnetico da 60 mm



Codice	Misura	Pz/Conf	Master
79010T	3,6V	10	10

AVVITATORE 12V CON PERCUSSIONE

Omologazione CE
 Tensione: CC 12V
 Alimentazione: ioni di litio, 1 * 1500 mAh (# 79049)
 Velocità a vuoto: 0-400 giri/min / 0-1500 giri/min
 Frizione: 18+1 steps di regolazione
 Coppia massima: 28 Nm.
 Mandrino: mandrino autoserrante da 10 mm
 Interruttore: avanti e indietro
 Caricabatterie: CA 100-240 V, 50/60 Hz
 Tempo di ricarica: 2 ore di ricarica
 Indicatore di carica della batteria luce led di servizio
 Impugnatura morbida
 Confezionato in scatola



Codice	Misura	Pz/Conf	Master
79041T	12V	1	10

AVVITATORE A IMPULSI 12V CON PERCUSSIONE ATTACCO 1/4"

Omologazione CE
 Tensione: CC 12V
 Alimentazione: ioni di litio, 1 * 1500 mAh
 Velocità a vuoto: 0-2800 giri/min
 Tasso di impatto: 3100 bpm
 Coppia massima: 100Nm
 Portapunte a sgancio rapido da 1/4" (6,35 mm).
 Caricabatterie: CA 100-240 V, presa europea
 Tempo di ricarica: 2 ore
 Indicatore di carica della batteria
 Impugnatura morbida
 Confezionato in scatola



Codice	Misura	Pz/Conf	Master
79037T	12V	1	10

SUPPORTO PER SMERIGLIATRICE ANGOLARE 115-125mm



Codice	Misura	Pz/Conf	Master
10501T	115-125W	2	4

SMERIGLIATRICE ANGOLARE 950W 115/125mm

Omologazione CE
 Potenza in ingresso: 950 W
 Voltaggio: 230 V
 Frequenza: 50 Hz
 Velocità a vuoto: 9500 giri/min
 Diametro disco: 125 mm
 Spina e cavo: approvato CE 2 m
 Protezione antispegnimento
 Gli accessori contengono: 1 paio di spazzole di carbone 1 impugnatura ausiliaria 1 chiave inglese



Codice	Misura	Pz/Conf	Master
88580T	950W	1	8

TRAPANO A PERCUSSIONE

Omologazione CE
 Potenza in ingresso: 500 W
 Tensione nominale: 230 V
 Frequenza: 50 Hz
 Velocità a vuoto: 0-2900 giri/min
 Frequenza di impatto: 0-46400 bpm con funzione di percussione.
 Capacità del mandrino 13 mm
 Max in acciaio: 13 mm
 Max in cemento: 13 mm
 Max in legno.
 Cavo di alimentazione approvato VDE 2 mt.
 Include:
 1 manico laterale,
 1 pz chiave per mandrino da 13 mm,
 1 pz calibro di profondità (plastica)



Codice	Misura	Pz/Conf	Master
79504AT	650W	1	6
79506AT	850W	1	8

SUPPORTO A COLONNA PER TRAPANO

Omologazione GS
 Da utilizzare con trapani
 Barra della colonna solida
 Base robusta con asole per il montaggio della morsa della macchina
 Altezza colonna: 510 mm
 Diametro colonna: 25 mm
 Profondità di alimentazione: 60 mm
 Diametro del collare: 43 mm e 38 mm
 Dimensioni base: 22x16 cm
 Peso netto: 3 kg
 Corpo in pressofusione di alluminio Imballaggio: scatola



Codice	Misura	Pz/Conf	Master
10500T	43mm	1	4

TASSELLATORE 800W EX 79511T

Omologazione CE

Potenza in ingresso: 800 W

Tensione nominale: 220-240 V

Frequenza: 50Hz

Velocità a vuoto: 0-1200 giri/min

Velocità di impatto: 0-5500 bpm

Energia di impatto: 2,8 J

Capacità di foratura: Acciaio: 13 mm, Calcestruzzo: 26 mm,

Legno: 40 mm. mandrino SDS.

Spina e cavo 2 mt. approvati VDE.

Gli accessori contengono 1 scalpello a punta: 13 x 2400 mm 1 scalpello piatto: 13 x 240 mm 3 punte SDS-plus: 6 x 140 mm, 8 x 140 mm, 110 x 140 mm 1 impugnatura ausiliaria 1 misuratore di profondità 1 manuale di istruzioni



Codice	Misura	Pz/Conf	Master
79510T	800W	1	4

INDUSTRIAL

MARTELLI DEMOLITORI 1500W

Potenza in ingresso: 1500 W

Tensione nominale: 230 V

Frequenza: 50 Hz

Velocità a vuoto: 780 giri/min

Velocità di impatto: 4300 bpm

Energia di impatto: 5,5 J

Capacità di perforazione: Acciaio: 13mm,

Calcestruzzo: 32mm,

Legno: 42mm

mandrino SDS.

Spina e cavo approvati VDE 2 mt.

Accessori: 1 scalpello a punta: 14x250mm

1 scalpello piatto 14x250mm

3 punte SDS-plus 8x150mm, 10x150mm, 12x150mm

1 paio di spazzole di carbone, coperchio antipolvere, bottiglia di olio

lubrificante, chiave inglese, manuale di istruzioni.

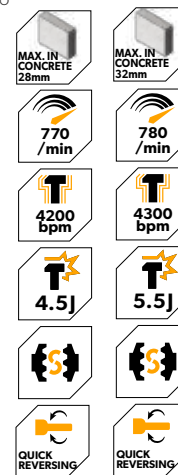

Codice	Misura	Pz/Conf	Master
88530T	1050W	1	3

88531T	1500W	1	3

DEMOLITORE SDS MAX 1250W

Omologazione GS/CE

Potenza in ingresso: 1250 W

Tensione nominale: 220-240 V

Frequenza: 50/60 HZ

Velocità a vuoto: 150-500 giri/min

Velocità di impatto: 1500-3100 bpm

Energia di impatto: 2-9 J

Mandrino SDS MAX

Spina e cavo: approvato VDE 2 m

Peso netto: 6,5 kg

Gli accessori contengono 1 scalpello a punta: 18x320 mm 1 scalpello piatto: 18x320 mm 1 vasetto di grasso 1 protezione antipolvere 1 paio di spazzole di carbone 1 bottiglia di olio lubrificante 1 chiave inglese 1 manuale di istruzioni

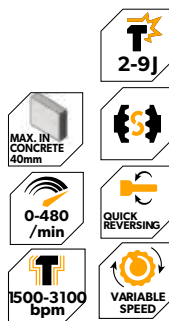

Codice	Misura	Pz/Conf	Master
88540T	1250W	1	2

INDUSTRIAL

DEMOLITORE CON MANDRINO ESAGONALE 1050W 10J

Omologazione CE

Potenza in ingresso: 1050 W

Tensione nominale: 230 V

Frequenza: 50 Hz

Frequenza d'impatto: 4000 bpm

Forza d'impatto: 10 J - 6 kg, mandrino HEX

Interruttore di blocco,

isolamento termico

Spina e cavo 2mt approvati VDE. Accessori: impugnatura ausiliaria, 1 scalpello a punta: 18 x 280mm, 1pz Scalpello piatto 22x18x280mm, 1 paio Spazzola di carbone, chiave inglese, manuale di istruzioni



Codice	Misura	Pz/Conf	Master
88550T	1050W	1	2

INDUSTRIAL

LUCIDATRICE 1400W EX 79528T

Omologazione CE
 Potenza in ingresso: 1400 W
 Tensione nominale: 220-240 V
 Frequenza: 50/60Hz
 Velocità a vuoto: 1000-3300 giri/min, velocità variabile
 Diametro del tampone di lucidatura: 180 mm Filettatura mandrino: M14
 Scatola ingranaggi in alluminio resistente
 Tampone per lucidatura 1pc
 Cover lucidante 1pc
 1 chiave esagonale
 1 paio di spazzole di ricambio



180mm
 800-3300 /min
 VARIABLE SPEED

VARIABLE SPEED

M14

Codice	Misura	Pz/Conf	Master
88598T	1400W	1	4

SEGA CIRCOLARE 1300W

Omologazione CE
 Potenza in ingresso: 1300 W
 Tensione nominale: 230-240 V
 Frequenza: 50 Hz
 Velocità a vuoto: 0-5000 giri/min . Interruttore con blocco.
 Diametro lama: 185 mm (7-1/4") 24 T
 Profondità di taglio massima: 65 mm a 90° / 44mm 45°
 Spina e cavo approvati VDE 2mt.
 Caratteristiche: Protezione in alluminio pressofuso.
 Blocco mandrino per la sostituzione della lama.
 Gli accessori contengono,
 Chiave esagonale, Spazzola di carbone,
 Lama TCT per la lavorazione del legno,
 Guida parallela, manuale di istruzioni



185mm
 5000 /min
 45-90° BEVEL CUT
 LOCK-OFF SWITCH

Codice	Misura	Pz/Conf	Master
79532T	1300W	1	4

TRONCATRICE 1800W

Omologazione CE
 Potenza in ingresso: 1800 W
 Tensione nominale: 220-240 V
 Frequenza: 50 Hz
 Velocità a vuoto: 5000 giri/min
 Dimensioni lama: 255 mm
 Base in alluminio
 Con funzione laser
 Tagli obliqui 0-45° a sinistra e a destra
 Tagli smussati fino a 45° a sinistra
 Taglio max. capacità: 90° x 0° - 140 x 70 mm 45° x 0° - 95 x 70 mm 90° x 45° - 140 x 40 mm 45° x 45° - 95 x 40 mm
 Sacco per la polvere per mantenere pulita l'area di lavoro
 Accessori: 1pz Morsetto di lavoro 1pz ala di estensione 1 pz lama per sega TCT 255 mm (10 ") x 30 mm x 32 T
 1 pz sacchetto per la polvere 1 pz chiave esagonale



210mm Blade size
 5000 /min
 0-45° WORKING TABLE
 45-90° BEVEL CUT

ALUMINIUM BASE

Codice	Misura	Pz/Conf	Master
79530T	1800W	1	1

FRESATRICE VERTICALE 2100W

Omologazione CE
 Potenza in ingresso: 2100 W
 Tensione nominale: 220-240 V
 Frequenza: 50/60 Hz
 Velocità a vuoto: 8000-23500 giri/min, velocità variabile
 Profondità di immersione: 0-55 mm
 Dimensioni codolo: 5/16", 8 mm, 12 mm, 1/2 "
 Piano in alluminio
 Con 1 guida in alluminio 1 set di guida parallela
 Con 1 set di spazzole di ricambio
 Con 1 connettore per sacchetto per la polvere



12000-23000 /min
 0-50 mm
 VARIABLE SPEED
 DEPTH ADJUSTMENT

12mm 1/2"
 1/4" 6mm 8mm

ALUMINIUM PLANE FLOOR

Codice	Misura	Pz/Conf	Master
79534T	2100w	1	2

PIALLATRICE 900W

Omologazione CE
 Potenza in ingresso: 900 W
 Tensione nominale: 230-240 V
 Frequenza: 50 Hz
 Velocità a vuoto: 16000 giri/min
 Larghezza di piallatura: 82 mm
 Profondità di piallatura: 0-3 mm
 Base in alluminio resistente
 Copertura laterale in alluminio
 Con 2 lame piallatrici da 65Mn
 Con cintura 1 pz
 Con 1 set di guide parallele
 Con 1 guida di profondità



Codice	Misura	Pz/Conf	Master
79535T	900W	1	4

SEGA A GATTOCCIO 710W EX 79541T

Omologazione CE
 Potenza in ingresso: 710 W
 Tensione nominale: 220-240 V
 Frequenza: 50/60 Hz
 Velocità a vuoto: 0-2800 giri/min
 Lunghezza corsa: 20 mm
 Max in acciaio: 6 mm
 Max in legno: 115 mm
 Spina e cavo approvati VDE 2 mt.



Codice	Misura	Pz/Conf	Master
79540T	710W	1	6

SCANALATORE 1500W

Omologazione CE
 Potenza in ingresso: 1500 W
 Tensione nominale: 230-240 V
 Frequenza: 50 Hz
 Velocità a vuoto: 8500 giri/min
 Diametro del disco: 125 mm
 Filettatura mandrino: M14
 Profondità di taglio: 5-29 mm
 Larghezza di taglio: 8-30 mm
 Taglio a secco
 Blocco del mandrino
 Regolazione della profondità
 Funzione di blocco
 Disco da taglio diamantato 2 pezzi
 1 chiave a brugola
 1 chiave per flangia
 1 chiave a brugola con manico
 Imballaggio: scatola



M14



Codice	Misura	Pz/Conf	Master
79537T	1500W	1	4

SEGHETTO ALTERNATIVO 800W

Omologazione CE
 Potenza in ingresso: 800 W
 Tensione: 230 V
 Frequenza: 50 HZ
 Velocità a vuoto: 800-3000 giri/min
 Pendolo orbitale a 4 stadi
 Base in alluminio
 Con funzione laser
 Capacità di taglio: Legno: 100 mm, Acciaio: 10 mm
 Gli accessori contengono: lama per seghetto alternativo, raccordo per la raccolta della polvere, chiave esagonale, guida parallela, manuale di istruzioni.

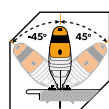

built-in laser
LASERASSIST™



Codice	Misura	Pz/Conf	Master
79552T	600W	1	6

79551T	800W	1	6

MINI SMERIGLIATRICE 135W CON VALIGETTA E 109 ACCESSORI

Omologazione CE
 Potenza in ingresso: 135 W
 Tensione nominale: 230 V
 Frequenza: 50/60 HZ
 Velocità a vuoto: 10000-32000 giri/min
 Gli accessori contengono: 10 pezzi di mole 2 pezzi diamantati 1 pezzo di mandrino per nastri abrasivi 1 pezzo di mandrino per dischi da taglio 1 pezzo di mandrino per ruote di feltro 36 pezzi di taglio-off ruote 4 pezzi ruote in feltro 4 pezzi nastri abrasivi 2 pezzi punte da trapano 1 pezzo pietra affilata 40 dischi abrasivi 1 pezzo scudo per gli occhi 1 pezzo albero flessibile



Codice	Misura	Pz/Conf	Master
79555T	135W	1	6

LEVIGATRICE TRIANGOLARE 200W EX 79561T

Approvato CE
 Potenza in ingresso: 200 W
 Tensione: 230 V
 Frequenza: 50 Hz
 Frequenza orbitale: 12000 rpm
 Dimensioni pad: 140 * 140 * 90 mm.
 Gli accessori contengono: 3 fogli abrasivi



Codice	Misura	Pz/Conf	Master
79562T	200W	1	6

LEVIGATRICE ROTORBITALE 280W EX 79565T

Approvato CE
 Potenza in ingresso: 280 W
 Tensione: 230 V
 Frequenza: 50 Hz
 Frequenza orbitale: 6000-13000 rpm
 Dimensioni pad: Ø125 mm
 Gli accessori contengono:
 3 pezzi di carta abrasiva,
 1 sacchetto per polvere



Ø
125mm



Codice	Misura	Pz/Conf	Master
79566T	280W	1	6

LEVIGATRICE ROTORBITALE 450W

Approvato CE
 Potenza in ingresso: 450 W
 Tensione: 230 V
 Frequenza: 50 Hz
 Frequenza orbitale: 4000-10000rpm
 Dimensioni pad: Ø150 mm
 Gli accessori contengono:
 3 pezzi di carta abrasiva
 1 sacchetto per polvere



Ø
150mm



Codice	Misura	Pz/Conf	Master
79567T	450W	1	6

LEVIGATRICE ORBITALE 220W EX 79563T

Approvato CE
 Potenza in ingresso: 220 W
 Tensione: 230 V
 Frequenza: 50 Hz
 Frequenza orbitale: 6000-12000 rpm
 Dimensioni pad: 187x92,5 mm
 Gli accessori contengono: 3 pezzi di carta abrasiva e sacchetto per la polvere



Codice	Misura	Pz/Conf	Master
79564T	220W	1	6

PISTOLA A SPRUZZO HVLP 400W

Omologazione CE
 Potenza in ingresso: 400 W
 Tensione nominale: 220-240 V
 Frequenza: 50/60 Hz
 Serbatoio 800 ml
 Max. Viscosità: 60din/sec
 Max. flusso 800 ml/min
 Ugello: F1,8/2,6 mm
 Peso netto: 1,3 kg
 Cavo da 2 m approvato VDE
 Accessori: 1 misurino 1 ugello da 2,6 mm 1 perno di pulizia



Codice	Misura	Pz/Conf	Master
79578T	400W	1	6

LEVIGATRICE A NASTRO 810W

Omologazione CE
 Potenza in ingresso: 810 W
 Tensione nominale: 230V
 Frequenza: 50 Hz
 Dimensioni del rullo: 533x76 mm
 Velocità a vuoto: 200-380 M/min
 Con sacchetto per la polvere



NEW



Codice	Misura	Pz/Conf	Master
79568T	810W	1	4

PISTOLA A SPRUZZO HVLP 650W

Omologazione CE
 Potenza in ingresso: 650 W
 Tensione nominale: 220-240 V
 Frequenza: 50/60 Hz
 Serbatoio 800 ml.
 Max. Viscosità: 60din/sec
 max. flusso 800 ml/min
 Ugello: F1,8/2,6 mm
 Peso netto: 2,2 kg
 Cavo approvato VDE da 2 m
 Accessori: 1 pezzo misurino 1 pezzo ugello da 2,6 mm 1 pezzo tracolla 1 pezzo perno di pulizia



Codice	Misura	Pz/Conf	Master
79579T	650W	1	4

LEVIGATRICE PER MURO 880W

Omologazione CE
 Potenza: 880W
 Tensione nominale: 230-240V
 Frequenza: 50 Hz
 Velocità a vuoto: 1000-2100/min
 Diametro del disco abrasivo: 225 mm
 Diametro platorello: 215 mm.
 Lunghezza cavo 4,5mt
 Albero telescopico: 1,5 m - 2,2 m, soft start.
 Funzione di auto-aspirazione, controllo variabile, con luce a LED, sacchetto per la polvere, 6 dischi abrasivi (2 pezzi da 120 grani, 2 pezzi da 180 grani, 2 pezzi da 240 grani), tubo flessibile 2 mt, adattatore di collegamento.



LED WORK LIGHT



- 1000-2100 /min
- VARIABLE SPEED
- SOFT START CONTROL
- SUCTION FUNCTION

Codice	Misura	Pz/Conf	Master
79585T	880W	1	1

BIDONE ASPIRAPOLVERE E LIQUIDI

Omologazione CE
 Potenza in ingresso: 1200 W
 Tensione: 220-240 V
 Frequenza: 50/60 Hz
 Serbatoio in acciaio inossidabile
 Capacità polvere: 30 l
 Flusso d'aria: 1,9 m³/min
 Pressione del vuoto: 17 KPa
 Tubo flessibile da 1,5 m
 Tubo di plastica 2 pezzi
 Filtrazione spugna 1 pezzo 1 set 2" 1 spazzola
 1 pz bocca piatta
 1 pz cartuccia colonnare
 Lunghezza totale del cavo 2,3 m
 Filtro HEPA



STAINLESS STEEL TANK



WET CLEANING

DRY CLEANING

30L

17KPa VACUUM PRESSURE

1.9m³/min

Codice	Misura	Pz/Conf	Master
79608T	1200W 30LT	1	1

AGITATORE PER VERNICI 1800W

Omologazione CE
 Miscelatore per cemento o pittura
 Voltaggio: 220-240V
 Frequenza: 50Hz
 Potenza assorbita: 1800W
 Velocità a vuoto: 180-400/300-700 rpm
 Filettatura morsetto: M14
 Diametro pala di miscelazione: 140mm
 Materiali idonei: intonaco, cemento, malta adesiva per piastrelle



SOFT START CONTROL



- 180-400/300-700 /min
- 2 SPEED GEARBOX
- 140mm
- VARIABLE SPEED

Codice	Misura	Pz/Conf	Master
79509T	1800W	1	2

BIDONE ASPIRAPOLVERE E LIQUIDI

Omologazione CE
 Potenza in ingresso: 2x1000 W
 Tensione: 220-240 V
 Frequenza: 50/60 Hz
 Serbatoio in acciaio inossidabile
 Capacità polvere: 70 L
 Flusso d'aria: 3 m³/min
 Pressione del vuoto: 18 KPa
 Tubo flessibile da 2,5 m
 2 tubi metallici
 2 spazzole quadrate da 40 cm
 1 filtro spugna
 1 set di spazzole a testa tonda
 1 pz grande bocca piatta
 1 pz cartuccia colonnare
 Lunghezza totale del cavo 2,3 m
 Filtro HEPA



STAINLESS STEEL TANK



WET CLEANING

DRY CLEANING

70L

18KPa VACUUM PRESSURE

3m³/min

Codice	Misura	Pz/Conf	Master
79609T	2X1000W 70LT	1	1

SUPPORTO PER SMERIGLIATRICE ANGOLARE 230mm



Codice	Misura	Pz/Conf	Master
10502T	230W	2	4

SMERIGLIATRICE ANGOLARE 2350W

Omologazione CE
 Potenza in ingresso: 2350 W
 Voltaggio: 230 V
 Frequenza: 50 Hz
 Velocità a vuoto: 6000 giri/min
 Diametro disco: 230 mm
 Interruttore di prevenzione autobloccante
 Velocità regolabile.
 Spina e cavo omologato CE 2 mt.
 Gli accessori contengono: 1 paio di spazzole di carbone ,
 impugnatura laterale 1 chiave inglese 1 pz chiave esagonale 6 mm.



Codice	Misura	Pz/Conf	Master
79524T	2350W	1	2

IDROPULITRICE 1700W

Omologazione CE
 Potenza 1700 W
 Tensione nominale: 230 V
 Frequenza 50 Hz.
 Pressione nominale: 90 Bar (1300 psi)
 Pressione massima della pompa: 135 Bar (2000 psi)
 Portata: 5 l/min.
 Funzione di aspirazione automatica
 Protezione della temperatura
 Protezione della pressione
 Spina e cavo approvati VDE 5 m.
 Gli accessori contengono 1 set pistola di lavaggio regolabile,
 tubo flessibile ad alta pressione 7 metri 1 bottiglia persapone,
 adattatore per rubinetto, connettore per tubo flessibile,perno di pulizia.



Codice	Misura	Pz/Conf	Master
79589T	1700w	1	1

UTENSILE MULTIFUNZIONE 300W

Omologazione CE
 Potenza in ingresso: 300 W
 Tensione: 230-240 V
 Frequenza: 50 Hz
 Velocità a vuoto: 15000-22000 opm
 Contiene accessori:
 1 raschietto piatto
 1 lama universale
 1 platorello triangolare
 1 platorello
 1 lama semicircolare
 2 fogli abrasivi (grana 80 - 120)



Codice	Misura	Pz/Conf	Master
79558T	300W	1	6

MONTA CARICHI / PARANCO 800W

INDUSTRIAL

Omologazione CE/GS
 Potenza in ingresso: 800 W
 Tensione nominale: 230 V
 Frequenza: 50 Hz
 Peso di sollevamento: 250 Kg (linea singola) 500 Kg (linea doppia)
 Altezza di sollevamento: 12 m (linea singola), 6 m (linea doppia)
 Velocità di sollevamento: 8 m/min (singola linea), 4m/min (Linea doppia)
 Dispositivo di fine corsa superiore e inferiore
 Interruttore di arresto di emergenza
 Terminale di protezione termica



250kg/
500kg

Codice	Misura	Pz/Conf	Master
62491T	800W	1	2

SEGA A NASTRO 350W

Omologazione CE
 Potenza in ingresso: 350 W
 Tensione nominale: 220V
 Frequenza: 50Hz
 banco in alluminio 300x300mm
 inclinazione 45°-90°
 Massimo. altezza di taglio: 90 mm
 Lama: 1430mmx10mmx6T
 Altezza totale: 700 mm
 Peso netto: 18 kg
 Accessori
 Calibro obliquo 1pc
 1 guida parallela
 1 spingi pezzo
 1 chiave
 3 chiavi esagonali (S2.5, S3, S4)



900/min

45-90°
TABLE TILTING
RANGE

90mm
MAX. CUTTING
THICKNESS

300x300
mm
TABLE SIZE

NEW
**ALUMINIUM
WORK TABLE**

Codice	Misura	Pz/Conf	Master
79664T	350W	1	1

BANCO SEGA 1500W

Omologazione CE
 Potenza in ingresso: 1500 W
 Tensione nominale: 230V
 Frequenza: 50Hz
 Velocità a vuoto: 4800/m
 Dimensioni lama: 250x30x24T
 Capacità di taglio massima: 85 mm a 90°, 60 mm a 45°
 Campo di inclinazione lama: 0°- 45°
 Piano tavolo in lamiera
 Dimensioni del tavolo principale: 546 x 630 mm
 Dimensioni estensioni (sinistra/destra): 630 x 190 mm
 Dimensioni estensione (posteriore): 250x540 mm
 Accessori:
 Goniometro, guida, copertura di sicurezza lama, spingi pezzo, lama 250x30x24T, chiave esagonale, chiave per mandrino, chiave a forchetta per staffa.



250mm

4800/min

0-45°
BEVEL CUT

45°
Ø53 mm

90°
Ø85 mm

**SHEET METAL
TABLE TOP**

Codice	Misura	Pz/Conf	Master
79660T	1500W	1	1

MORE
POWER



MP20^V
ONE POWERS ALL.

BORSA SOFT PORTAUTENSILI

ideale per elettroutensili MP20V cod.87223T - cod.87278T - cod. 87272T



Codice	Misura	Pz/Conf	Master
87212-1T	30cm	1	50

BORSA PORTAUTENSILI SERIE MP20V

Dimensioni: 41x20x26 cm

Peso netto: 790 g

Capacità di carico: 8,5 kg

Completamente rivestito con materiale flessibile, protegge perfettamente gli strumenti all'interno. due pannelli divisorii integrati.



Codice	Misura	Pz/Conf	Master
80042T	41x20x26mm	1	6

KIT AVVITATORE A BATTERIA CON PERCUSSIONE 20V

Velocità a vuoto: 0-400 / 0-1500 /min

Frequenza d'impatto: 6000 / 22500 bpm

Capacità del mandrino: 1,5-10 mm

Massimo. coppia: 35Nm

Frizione: 21+1+1

Max.capacità di foratura nel legno: 25mm

Max.capacità di foratura in acciaio: 10mm

Max.capacità di foratura nel calcestruzzo: 10mm

Mandrino autoserrante 10mm

Bloccaggio automatico del mandrino

Selezione della velocità del passo

Regolazione elettronica della velocità

Funzione inversa

Coppia variabile

3 modalità (avvitamento / foratura / foratura a percussione)

Luce a led



Codice	Misura	Pz/Conf	Master
87213T	20V	1	5

KIT AVVITATORE 20V CON PERCUSSIONE

Velocità a vuoto: 0-400 / 0-1500 /min

Frequenza d'impatto: 6000 / 22500 bpm

Capacità del mandrino: 1,5-10 mm

Massimo coppia: 35Nm

Frizione: 21+1+1 regolazione

Capacità massima di foratura nel legno: 25 mm

Capacità massima di foratura nell'acciaio: 10 mm

Capacità massima di foratura nel calcestruzzo: 10 mm



Codice	Misura	Pz/Conf	Master
87214T	20V	1	6

KIT AVVITATORE AD IMPULSI BRUSHLESS 20V ATTACCO ESAGONALE 1/4"

Velocità: 0-2900 /min
 battute: 0-3000 ipm
 coppia: 200 Nm
 Tipo di mandrino: 1/4" esagonale
 Motore senza spazzole
 Omologazione CE
 Batteria agli ioni di litio
 Portautensili esagonale da 1/4"
 Regolazione elettronica della velocità
 Coppia variabile
 Funzione inversa
 Luce LED integrata
 Indicatore di carica della batteria a LED
 Gancio per cintura
 Include:
 2 pacchi batteria da 2,0 Ah
 1pz Caricabatterie : 220-240VAC 50/60Hz,
 1 ora di ricarica rapida



Codice	Misura	Pz/Conf	Master
87256T	20V	1	4

KIT AVVITATORE AD IMPULSI BRUSHLESS 20V ATTACCO QUADRO 1/2"

Attacco quadro: 1/2"
 Velocità: 0-2500/min
 battute: 0-3000 ipm
 coppia: 300 Nm
 Motore senza spazzole
 Omologazione CE
 Batteria agli ioni di litio
 Regolazione elettronica della velocità
 Funzione inversa
 Coppia variabile
 Indicatore di carica della batteria a LED
 Luce LED integrata
 Gancio per cintura
 Include:
 2 pacchi batteria da 2,0 Ah
 1pz Caricabatterie: 220-240VAC 50/60Hz,
 1 ora di ricarica rapida



Codice	Misura	Pz/Conf	Master
87258T	20V	1	4

KIT AVVITATORE BRUSHLESS 20V CON PERCUSSIONE

Velocità : 0-500 / 0-2000 /min
 Percussione: 8000/32000 bpm
 Capacità mandrino: 2-13 mm
 Massimo coppia: 58 Nm
 Frizione: regolazione 21+1+1
 Max. capacità di foratura nel legno: 38 mm
 Max. capacità di foratura in acciaio: 13 mm
 Max. capacità di foratura nel calcestruzzo: 13mm
 Motore senza spazzole
 Omologazione CE
 Batteria agli ioni di litio
 Mandrino autoserrante in metallo
 Bloccaggio automatico del mandrino
 Selezione della velocità del passo
 Regolazione elettronica della velocità
 Funzione inversa
 Coppia variabile
 3 modalità (avvitamento / foratura / perforazione a percussione)
 luce a led



Codice	Misura	Pz/Conf	Master
87254T	20V	1	4

KIT AVVITATORE 20V CON PERCUSSIONE

Velocità a vuoto: 0-450 / 0-1700 /min
 Frequenza di impatto: 7200 / 27200 bpm
 Capacità del mandrino: 2,0-13 mm
 Massimo coppia: 55 Nm
 Frizione: 21+1+1 regolazione
 Max. capacità di foratura nel legno: 35mm
 Max. capacità di foratura in acciaio: 13 mm
 Max. capacità di foratura nel calcestruzzo: 13mm
 Omologazione CE
 Batteria agli ioni di litio
 Mandrino autoserrante in metallo
 Bloccaggio automatico del mandrino
 Selezione della velocità del passo
 Regolazione elettronica della velocità
 Funzione inversa
 Coppia variabile
 3 modalità (avvitamento / foratura / perforazione a percussione)
 Luce a led



Codice	Misura	Pz/Conf	Master
87215T	20V	1	5

SMERIGLIATRICE ANGOLARE BRUSHLESS

Voltaggio: 20V
 Diametro disco: 125 mm / 5'''
 Velocità a vuoto: 10000 giri/min
 Filettatura del mandrino: M14
 Motore senza spazzole
 Omologazione CE
 Soft start
 Riavvia la protezione
 Frizione di sicurezza
 Involucro di protezione a regolazione rapida
 Impugnatura morbida
 *Batteria/caricatore non inclusi
 Con impugnatura laterale 1pz e chiave inglese



Codice	Misura	Pz/Conf	Master
87278T	20V	1	4

SEGA CIRCOLARE BRUSHLESS 190MM

Voltaggio: 20V
 Velocità a vuoto: 3800 giri/min
 Lama per sega circolare: Ø190mm
 Foro: Ø20mm
 Profondità di taglio massima a 90°: 62 mm
 Profondità di taglio massima a 45°: 43 mm
 Motore senza spazzole
 Omologazione CE
 Soft start
 Funzione di blocco del mandrino
 Interruttore di blocco con maniglia ausiliaria
 Piastra base in alluminio
 Luce LED integrata
 *Batteria/caricatore non inclusi



Codice	Misura	Pz/Conf	Master
87282T	20V	1	2

SEGA A GATTOCCIO BRUSHLESS

Voltaggio: 20V
 Velocità a vuoto: 0-2500 giri/min
 Lunghezza corsa: 28 mm
 Capacità di taglio in legno: 180mm
 Capacità di taglio in metallo: 8mm
 Motore senza spazzole
 Omologazione CE
 Regolazione della frequenza delle corse
 Funzione di blocco
 Sistema di cambio rapido della lama della sega
 Luce LED integrata
 Impugnatura morbida
 *Batteria/caricatore non inclusi



Codice	Misura	Pz/Conf	Master
87280T	20V	1	6

TASSELLATORE DEMOLITORE BRUSHLESS

Batteria: 20V
 Velocità a vuoto: 0-1200 /min
 Colpi al minuto: 0-4800 bpm
 Energia d'impatto: 2,5 J
 Capacità foratura calcestruzzo: 24 mm
 Capacità foratura acciaio: 13 mm
 Capacità foratura trapano in legno: 40 mm
 Motore senza spazzole
 Omologazione CE
 Mandrino SDS Plus
 Sistema di stabilizzazione della velocità di rotazione
 Sistema antivibrazioni
 Frizione di sicurezza
 *Batteria/caricatore non inclusi



Codice	Misura	Pz/Conf	Master
87272T	20V	1	4

SEGA CIRCOLARE A BATTERIA 160MM

Tensione: 20V
 Velocità a vuoto: 3500 /min
 Lama: Ø165mm, 6-1/2"
 Alesaggio: Ø20mm e 5/8"
 Massima profondità di taglio a 90°: 53mm
 Profondità massima di taglio a 45°: 38mm
 Omologazione CE
 Soft start
 Piastra in alluminio.
 *Batteria/caricatore non inclusi



*LAMA NON INCLUSA



Codice	Misura	Pz/Conf	Master
87225T	20V	1	2

LEVIGATRICE ROTORBITALE

Omologazione CE
 Tensione batterie: 20V
 Diametro del cuscinetto: 125 mm
 Velocità a vuoto: 7000-11000 /min
 Diametro del tubo della polvere: 39,5mm
 1 sacchetto per la polvere
 2 fogli di carta vetrata inclusi in confezione
 *Batteria/caricatore non incluso



VARIABLE SPEED



Codice	Misura	Pz/Conf	Master
87233T	20V	1	6

SEGA A GATTOCCIO

Voltaggio pacco batterie: 20V
 Velocità a vuoto: 0-2800 giri/min
 Lunghezza corsa: 22 mm (7/8")
 Capacità di taglio nel legno: 125 mm (5")
 Capacità di taglio in metallo: 6 mm (1/4") Omologazione CE
 Piastra di base a regolazione rapida
 Interruttore di blocco
 Sistema di cambio rapido della lama della sega
 Luce LED integrata
 Impugnatura morbida
 *Batteria/caricatore non inclusi



*LAMA NON INCLUSA



Codice	Misura	Pz/Conf	Master
87228T	20V	1	6

SMERIGLIATRICE ANGOLARE 115MM

Voltaggio : 20V
 Diametro: 115 mm / 4-1/2"
 Velocità a vuoto: 8500 giri/min
 Filettatura del mandrino: M14
 Omologazione CE
 SOFT START
 Impugnatura morbida
 *Batteria/caricatore non inclusi
 impugnatura laterale 1pz e chiave inglese 1pz
 *Batteria/caricatore non inclusi



Codice	Misura	Pz/Conf	Master
87223T	20V	1	4

TORCIA DA LAVORO

Voltaggio: 20V
 Potenza LED: 10W
 Lumen: 1000Lm (100%) / 500Lm
 CCT: 6500K (luce diurna)
 Orario di lavoro: 3 ore (20 V/2,0 Ah)
 Omologazione CE
 Impugnatura morbida
 Clip da cintura
 3 Selezioni: 1000lm, 500lm, SOS, Off
 *Batteria/caricatore non inclusi



MP20V
LITHIUM-ION
10W
6500K



Codice	Misura	Pz/Conf	Master
87311T	20V	1	8

FARO DA LAVORO

VOLTAGGIO: 20V
 Potenza LED: 20W
 Numero di LED: 36
 Lumen: 2000Lm (100%) / 1000Lm (50%)
 CCT: 6500K (luce diurna)
 Orario di lavoro: 3 ore (20 V/2,0 Ah)
 Omologazione CE
 Design compatto
 Supporto girevole
 3 SELEZIONI: 2000lm, 1000lm, SOS, Off
 *Batteria/caricatore non inclusi



MP20V LED
LITHIUM-ION
20W
6500K



Codice	Misura	Pz/Conf	Master
87312T	20V	1	8

BIDONE ASPIRAPOLVERE E LIQUIDI A BATTERIA

Tensione batterie: 20V
 Potenza in uscita: 150W
 Capacità polvere: 20L
 Serbatoio in acciaio inossidabile
 Vuoto: =10Kpa
 Flusso d'aria: 10L/s
 Diametro tubo F32mm
 1 tubo flessibile da 1,5 metri
 1 tubo metallico telescopico in acciaio inossidabile da 48 cm a 78 cm, 15 posizioni
 1 bocca piatta
 Spazzola per pavimenti 1pc per bagnato e asciutto
 Ruote universali 4 pezzi
 1 filtro HEPA
 1 filtro a colonna pulibile
 *Batteria/Caricatore non incluso



NEW

Codice	Misura	Pz/Conf	Master
87338T	20 litri	1	1

SOFFIATORE BRUSHLESS

Voltaggio pacco batterie: 2x20V
 Velocità a vuoto: 17500/22500 /min
 Potenza massima in uscita: 800 W
 Velocità dell'aria: alta 59 m/s, bassa 47 m/s
 Volume d'aria: alto 345 CFM / basso 360 CFM
 Peso netto: 2,5 kg
 Motore senza spazzole
 Omologazione CE
 Design a 2 velocità per abbinare la velocità all'applicazione
 Grilletto di controllo della velocità variabile
 Buona ergonomia e layout equilibrato
 Corpo leggero
 Estremità gommata del tubo di soffiaggio per proteggere le superfici delicate
 *Batteria/caricatore non inclusi



MP20V LITHIUM-ION
BL BRUSHLESS MOTOR



Codice	Misura	Pz/Conf	Master
87340T	2x20V	1	2

ELETTROSEGA A BATTERIA BRUSHLESS

Voltaggio pacco batterie: 2x20V
 Potenza in uscita: 1000 W
 Lunghezza della barra di guida: 14" / 355 mm
 Velocità della catena: 6 m/s e 12 m/s
 Passo catena: 3/8"
 Peso netto: 3,8 kg
 Motore senza spazzole
 Omologazione CE

Alta velocità della catena per un taglio veloce
 Grilletto di controllo della velocità variabile Sistema di regolazione catena a cambio rapido Freno elettronico + freno meccanico
 *Batteria/caricatore non inclusi



Codice	Misura	Pz/Conf	Master
87360T	2x20V	1	2

ELETTROSEGA PALMARE A BATTERIA BRUSHLESS

tensione: 20V
 Potenza in uscita: 400W
 Lunghezza della barra: 8" / 200 mm
 Velocità della catena: 7,5 m/s
 Passo della catena: 1/4", serbatoio olio: 35 ml
 Peso netto: 2,6 kg, Motore brushless
 Omologazione CE
 Sistema di lubrificazione automatica
 Sistema di regolazione della catena a cambio rapido, paraspruzzi.
 *Batteria/caricatore non incluso



Codice	Misura	Pz/Conf	Master
87366T	20V	1	4

ELETTROSEGA A BATTERIA

Voltaggio pacco batterie: 20V
 Potenza in uscita: 400 W
 Lunghezza della barra di guida: 250 mm Velocità della catena: 6 m/s
 Passo catena: 3/8"
 Peso netto: 2,6 kg
 Alta velocità della catena per un taglio veloce Grilletto di controllo della velocità variabile Sistema di regolazione catena a cambio rapido Freno elettronico + freno meccanico
 *Batteria/caricatore non inclusi



Codice	Misura	Pz/Conf	Master
87362T	20V	1	2

TAGLIASIEPI A BATTERIA

Voltaggio: 20V
 Potenza in uscita: 200 W
 Lunghezza di taglio: 18" / 450 mm
 Forza di taglio: f18mm
 Corse: 0-2000 SPM
 Peso netto: 2 kg
 Omologazione CE
 Denti della lama rettificati al diamante su entrambi i lati
 La lama da 65Mn aumenta la capacità di taglio
 Arresto rapido elettronico della lama
 Design a basse vibrazioni
 Ergonomia perfetta e impugnatura soft-grip
 *Batteria/caricatore non inclusi



Codice	Misura	Pz/Conf	Master
87370T	20V	1	2

TAGLIABORDI A BATTERIA

Voltaggio: 20V
 Potenza in uscita: 200 W
 Velocità a vuoto: 7500 giri/min
 Capacità di taglio (diametro): 300 mm
 Angolo di taglio della regolazione della testa: 0° / 22,5° / 45° / 67,5° / 90°
 Linea di taglio max.: 1,6 mm
 Peso netto: 1,8 kg
 Omologazione CE
 2 tubi telescopici in alluminio con funzione di rifilatura
 Cornice di protezione dei fiori
 La maniglia ausiliaria può essere ruotata
 Ergonomia perfetta e impugnatura soft-grip
 *Batteria/caricatore non inclusi



Codice	Misura	Pz/Conf	Master
87372T	20V	1	2

KIT CESCOIA A BATTERIA BRUSHLESS

Capacità di taglio: 20/30 mm
 Peso netto: 2,4 kg
 Motore senza spazzole
 Omologazione CE
 Batteria agli ioni di litio
 Lama da taglio SK5
 Regolazione della capacità di taglio
 Velocità elettronica
 Impugnatura morbida
 Con cinturino da polso
 Include:
 2 batterie da 2,0 Ah
 1 Caricabatterie 1pc: 220-240VAC 50/60Hz,
 1 ora di ricarica rapida
 Imballaggio: valigetta



Codice	Misura	Pz/Conf	Master
87380T	20V	1	4

DECESPUGLIATORE A BATTERIA

Voltaggio pacco batterie: 2x20V;
 Potenza in uscita: 450 W;
 Velocità a vuoto: 4000 / 5000/min
 Capacità di taglio per erba (diametro): 400 mm;
 Capacità di taglio della spazzola (diametro): 255 mm
 Linea di taglio: 2,0 mm;
 Peso netto: 5,2 kg
 Motore brushless
 2 tubi telescopici in alluminio con funzione, protezione dei fiori.
 La maniglia ausiliaria può essere ruotata
 *Batteria/caricatore non inclusi



Codice	Misura	Pz/Conf	Master
87376T	2x20V	1	2

CESCOIA A BATTERIA BRUSHLESS

Voltaggio: 20V
 Capacità di taglio: 20/30 mm
 Peso netto: 0,7 kg
 Motore senza spazzole
 Omologazione CE
 Batteria agli ioni di litio
 Lama da taglio SK5
 Regolazione della capacità di taglio
 Velocità elettronica
 Impugnatura morbida
 Con cinturino da polso
 *Batteria/caricatore non inclusi



Codice	Misura	Pz/Conf	Master
87381T	20V	1	6

CORPO AVVITATORE AD IMPULSI BRUSHLESS ATTACCO ESAGONALE 1/4"

INDUSTRIAL

Velocità a vuoto: 0-2900 /min
Tasso di impatto: 0-3000 ipm
Coppia max: 200Nm
Tipo di mandrino: esagonale da 1/4"
Portautensili esagonale da 1/4".
Regolazione elettronica della velocità
Coppia variabile
Funzione inversa
Luce LED integrata
*Batteria/caricatore non inclusi



1/4"
6.35mm

BL BRUSHLESS MOTOR

TOOL ONLY

Codice	Misura	Pz/Conf	Master
87257T	20V	1	6

CORPO AVVITATORE 20V CON PERCUSSIONE BRUSHLESS

INDUSTRIAL

Velocità a vuoto: 0-500 0-2000 /min;
Tasso di impatto: 8000/32000 bpm;
Capacità del mandrino: 2-13 mm - coppia: 58Nm
Frizione: impostazione 21++1+1
Capacità massima di foratura nel legno: 38 mm;
Capacità massima di foratura nell'acciaio: 13 mm;
Capacità massima di foratura nel calcestruzzo: 13 mm
Mandrino autoserrante in metallo 13mm;
*Batteria/caricatore non inclusi



BL BRUSHLESS MOTOR

TOOL ONLY

Codice	Misura	Pz/Conf	Master
87255T	20V	1	6

PISTOLA PER COLLA A CALDO

Voltaggio pacco batterie: 20V
Corrente di lavoro: 2,0 A
Potenza in ingresso: 60 W
Tempo di riscaldamento: 3 minuti
Temperatura massima: 200°C
Diametro dello stick di colla: 11,2 mm
Capacità di incollaggio: 13-18 g/min
Maniglia ergonomica per un funzionamento efficiente Luce a led
Accessori inclusi: 3pz stick colla a caldo
*Batteria/caricatore non inclusi



TOOL ONLY

Codice	Misura	Pz/Conf	Master
87316T	20V	5	10

CORPO AVVITATORE AD IMPULSI BRUSHLESS ATTACCO QUADRO 1/2"

INDUSTRIAL

Attacco quadro: 1/2"
Velocità a vuoto: 0-2500/min
Tasso di impatto: 0-3000 ipm
Massimo. coppia: 300Nm
Motore brushless
Regolazione elettronica della velocità
Funzione inversa
Coppia variabile
Luce LED integrata
*Batteria/caricatore non inclusi



1/2"

BL BRUSHLESS MOTOR

TOOL ONLY

Codice	Misura	Pz/Conf	Master
87259T	20V	1	6

SEGHETTO ALTERNATIVO BRUSHLESS

Voltaggio: 20V
 Potenza in ingresso: 400 W
 Velocità a vuoto: 800-3500 giri/min
 Corsa: 23 mm
 Capacità di taglio: Legno 105mm; Acciaio 8mm; Alluminio 10mm
 Motore BRUSHLESS
 La grande base in alluminio rivestita con piastra in acciaio da 2 mm offre una maggiore resistenza
 Regolazione 0-45°
 *Batteria/caricatore non incluso



800-3500 /min

4 POSITION ORBITAL

VARIABLE SPEED

VARIABLE SPEED

LOCK-OFF SWITCH

Codice	Misura	Pz/Conf	Master
87284T	20V	1	8

UTENSILE MULTIFUNZIONE A BATTERIA

Voltaggio: 20V
 Controllo della velocità variabile: 8000/9600/11200/12800/14400/16000 giri/min
 Angolo di oscillazione: 3,2°
 Maniglia ergonomica per un funzionamento efficiente
 Luce a led
 Con tubo raccogli-polvere da 35 mm
 Sistema di bloccaggio senza attrezzi
 Accessori
 1 lama per taglio a tuffo
 1 lama raschietto in acciaio inossidabile
 1 Lama per sega a segmenti
 1 platorello per levigatura
 Set di 3 fogli abrasivi
 *Batteria/caricatore non incluso



8000-16000 /min

3.2° OSCILLATIONS ANGLE

VARIABLE SPEED

Codice	Misura	Pz/Conf	Master
87231T	20V	1	8

CARICATORE USB SERIE MP20V

Tensione: 20V
 Potenza in ingresso: 8-25 V
 Potenza in uscita: 5V/2A
 Omologazione CE
 Indicatore LED
 Protezione da cortocircuito
 Protezione da scarica eccessiva
 Indicatore di carica della batteria
 *Batteria/caricatore non incluso



5VDC 2A

LED WORK LIGHT

TOOL ONLY
 BATTERY AND CHARGER SOLD SEPARATELY

Codice	Misura	Pz/Conf	Master
87308T	20V	5	60

CARICATORE DOPPIO SERIE MP20V

Per caricare le batterie TOLSEN 20V 87472 e 87474
 Ricarica di 2 batterie TOLSEN 20V 4,0 Ah in 120 minuti
 Indicatore LED di carica della batteria



NEW

Codice	Misura	Pz/Conf	Master
87487T		5	60

BATTERIA 20V 4.0 AH SERIE MP20V

Voltaggio: 20V
 Batteria da 4,0 Ah
 Indicatore di carica della batteria a LED
 Compatibile con tutti gli utensili cordless TOLSEN MP20V
 Omologazione CE
 Caricatori compatibili: 87486 / 87482 / 87484
 Imballaggio: scatola



BATTERIA 20V 2.0 AH SERIE MP20V

Tensione: 20V
 Batteria da 2,0 Ah
 Indicatore di carica della batteria a LED
 Compatibile con tutti gli utensili cordless TOLSEN MP20V
 Omologazione CE
 Caricatori compatibili: 87485 / 87481 / 87484
 Imballaggio: scatola



MP20V LITHIUM-ION

4.0Ah



MP20V LITHIUM-ION

2.0Ah



Codice	Misura	Pz/Conf	Master
87474T	4.0Ah 20V	1	12

Codice	Misura	Pz/Conf	Master
87472T	2.0Ah 20V	1	24

CARICABATTERIE RAPIDO SERIE MP20V 2.0 AH

Potenza nominale: 60 W
 Tensione di uscita: 20 V CC
 Tensione di ingresso: 220-240 V CA
 Frequenza: 50/60 Hz
 Corrente di carica: 2,0 A
 Omologazione CE
 Per caricare la batteria TOLSEN 20V 2.0Ah 87472
 Ricarica della batteria TOLSEN 20V 2.0 Ah in 60 minuti
 Indicatore di carica della batteria a LED
 Europlug
 Imballaggio: scatola



CARICABATTERIE RAPIDO SERIE MP20V 4.0 AH

Potenza nominale: 110 W
 Tensione di uscita: 20 V CC
 Tensione di ingresso: 220-240 V CA
 Frequenza: 50/60 Hz
 Corrente di carica: 4,0 A
 Approvazione ETL
 Per caricare la batteria TOLSEN 20V 4.0Ah 87474
 Ricarica della batteria TOLSEN 20V 4.0 Ah in 60 minuti
 Indicatore di carica della batteria a LED
 Europlug
 Imballaggio: scatola



MP20V

LITHIUM-ION

**220-240VAC
 50/60Hz**

20VDC/2.0A

FAST CHARGING



MP20V

LITHIUM-ION

**220-240VAC
 50/60Hz**

20VDC/4.0A

FAST CHARGING



Codice	Misura	Pz/Conf	Master
87485T	60W 2.0Ah	1	24

Codice	Misura	Pz/Conf	Master
87486T	110W 4.0Ah	1	12

KIT LIVELLA LASER 20V 3X360° SERIE MP20V

Voltaggio batterie: 20V
 Potenza in ingresso: 20 W
 Lunghezza d'onda: 520 nm
 Luce verde 12 righe
 Precisione del raggio: linea H/V ±3 mm/10 m
 Intensità laser: Classe II
 Autolivellante: 0-4°
 Angolo espanso: H&V 360°
 Massimo. distanza di lavoro: 30 m (senza rilevatore)
 Durata: 15 ore circa

MP20' LITHIUM-ION



Codice	Misura	Pz/Conf	Master
87324T	20V	1	4

PISTOLA A SPRUZZO A BATTERIA 20V SERIE MP20V

Voltaggio batterie: 20V
 Potenza in ingresso: 300 W
 Capacità serbatoio vernice: 1000ml
 Massimo. flusso: 900 ml/min
 Massimo. Viscosità: 60din/sec
 Ugello in plastica: 1,8/2,6 mm
 Accessori: 1 misurino per viscosità, 1 ugello da 2,6 mm, 1 spillo per la pulizia



Codice	Misura	Pz/Conf	Master
87334T	20V	1	4

CASSETTA 65pz ASSORTITI CON AVVITATORE 12V

• Contiene:



1 trapano avvitatore a batteria 12V con batteria da 1.5Ah
1 caricatore CA 100-240 V



9 bussole Cr-V 1/4"X25mm: 5, 6, 7, 8, 9, 10, 11, 12, 13mm,

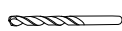

5 punte da trapano HSS: 3, 4, 5, 6, 8 mm



Set punte per legno 5 pezzi: 4, 5, 6, 8, 10 mm,



20 inserti Cr-V da 1/4" x 25 mm:
fissi 4, 5, 6 mm -PH1, PH2, PH3-PZ1, PZ2, PZ3,H3, H4, H5, H6- T10, T15, T20, T25, T27, T30



10 inserti Cr-V da 1/4" x 50 mm:
fissi 4, 5, 6,5 mm-PH1, PH2-PZ1, PZ2-T20, T25, T30



1 barra flessibile: 1/4"x300 mm,



1 porta inserti Cr-V da 1/4": 60 mm



2 adattatori per bussola 1/4" Cr-V,



1 metro flessibile 3 m x 16 mm,



1 mini livella da 22,5 cm



1 martello da carpentiere 225 g,



1 pinza universale 180 mm,



1 cacciavite per dadi: 1/4" x 100 mm



1 chiave regolabile da 200 mm,



1 cutter 18x100 mm,



1 cercafase 3x140 mm,



1 nastro isolante in PVC (rosso)



NEW

Codice	Misura	Pz/Conf	Master
85365T	12V	1	4

TOLSEN



TOLSEN

TOOLS AND MORE

